



UNIVERSAL MONITORING SYSTEM

MS5D, MS5



COMPLETE SOLUTION FOR MONITORING OF TEMPERATURE, HUMIDITY, PRESSURE AND OTHER VALUES IN THESE FIELDS:

- Food and beverages industry (HACCP)
- Pharmaceutical industry
- Blood stations, pharmacies
- Horticulture and cultivation of plants
- HVAC (heating, ventilation, air conditioning, cooling)
- Building and energy management
- Research and development
- Laboratories (GLP)

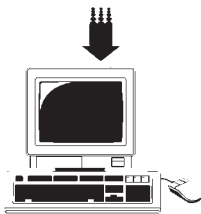

Sixteen channel dataloggers are designed for recording of values from transducers of variety of quantities, alarm state indication, and process control. Parameters of inputs are defined by the types of installed input modules. Datalogger with transducers configured accordingly to client order can measure analog signals, frequency, count impulses, evaluate two-state quantities and read data from devices compatible with ADAM Advantech protocol (ModBus is under preparation). Data is ready to download to a personal computer anytime via USB, RS232, RS485, Ethernet or GSM modem. Analyzing of the record is enabled after data download to the PC by means of the included program.

NEW FIRMWARE AND SOFTWARE ENABLE ESPECIALLY TO:

- Configure individually each input channel for measurement, alarm evaluation and data logging, including individual logging interval for each input.
- Each input channel can be individually programmed for different modes of record (continuous record, time dependent record, record only if specified logic conditions are matched, record triggered by external signal, etc.). It is enabled to record with shorter interval in case, measured values match previously defined conditions e.g. to map in detail trouble state. It is also enabled to memorize actual value and time if defined time event appears.
- Set up to four different logic conditions for each channel to activate alarm. Each condition compares measured values from inputs with set limits. It is possible to set hysteresis and delay of condition validity. Also weekly program can be set and distant condition from the PC.
- Indicate alarm states - visually, audibly, by relay contact, by e-mail or SMS message.
- Control processes by means of the optional relay module enabling to switch 16 output relays depending on alarm states.
- Receive information from data logger by means of SMS messages via GSM modem - actual values, alarms, memory occupation and other.
- Assign to each input channel name of actual recorded process to identify monitored object (e.g. type of monitored product). It is enabled to select this name from data logger keyboard during the operation.
- Store several configuration profiles (all logger parameters setting) for different measuring tasks and select profiles from MS5D logger keyboard or optional external terminal.
- Change easily input modules if different input signals are required for measurement.
- To connect input signals easily to removeable terminal connector. Each input channel is equipped with three terminals including shielding.

Following data loggers are available:



- MS5D** - completely equipped data logger
- dual line alphanumeric LCD display
- four control buttons
- 32 alarm LEDs



PEWA
Messtechnik GmbH
Weidenweg 21
58239 Schwerte
Tel.: 02304-96109-0
Fax: 02304-96109-88
E-Mail: info@pewa.de
Homepage: www.pewa.de



- MS5** - all functions as MS5D data logger
- without dual line alphanumeric LCD display
- without control buttons
- without 32 alarm LEDs
- common alarm indication with one LED



UNIVERSAL MONITORING SYSTEM MS5D, MS5

ARCHITECTURE OF MONITORING SYSTEM:

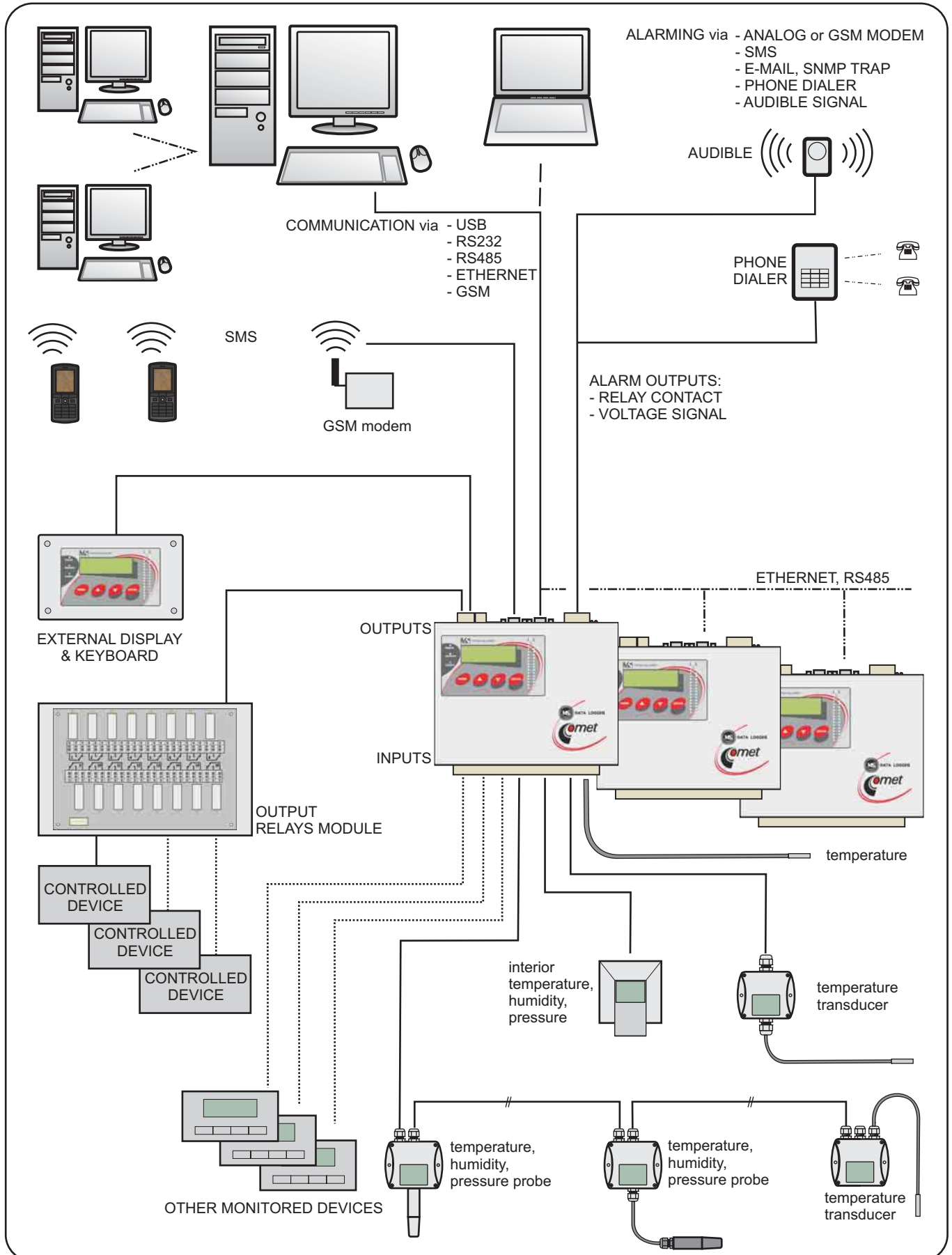



UNIVERSAL MONITORING SYSTEM

MS5D, MS5

TABLE OF INPUTS			
TYPE	MEASURED VALUE	ACCURACY	NOTE
A0	dc current 4 to 20 mA	$\pm 0.1\% \text{ FS}$	With source approximately 21V for two-wire transducers with current loop (e.g. temperature and humidity transducers Comet). Only galvanically not isolated.
A1*	dc current 4 to 20 mA	$\pm 0.1\% \text{ FS}$	for passive sensing of current
B0*	dc current 0 to 20 mA	$\pm 0.1\% \text{ FS}$	
B1*	dc current 0 to 1A	$\pm 0.1\% \text{ FS}$	
B2*	dc current 0 to 5A	$\pm 0.1\% \text{ FS}$	
C0	ac current 0 to 20mA	$\pm 1\% \text{ FS}$	galvanically isolated
C1	ac current 0 to 1A	$\pm 1\% \text{ FS}$	galvanically isolated
C2	ac current 0 to 5A	$\pm 1\% \text{ FS}$	galvanically isolated
D0*	dc voltage 0 to 100mV	$\pm 0.1\% \text{ FS}$	
D1*	dc voltage 0 to 1V	$\pm 0.1\% \text{ FS}$	
D2*	dc voltage 0 to 10V	$\pm 0.1\% \text{ FS}$	
D5*	dc voltage -10 to +10V	$\pm 0.1\% \text{ FS } (\pm 20\text{mV})$	New !
D4*	dc voltage +75V	$\pm 0.1\% \text{ FS}$	New !
E0	ac voltage 0 to 100mV	$\pm 1\% \text{ FS}$	galvanically isolated
E1	ac voltage 0 to 1V	$\pm 1\% \text{ FS}$	galvanically isolated
E2	ac voltage 0 to 10V	$\pm 1\% \text{ FS}$	galvanically isolated
E4	ac voltage 0 to 50V	$\pm 1\% \text{ FS}$	New ! galvanically isolated
F*	measurement of resistance	$\pm 0.1\% \text{ FS}$	two-wire connection
J*	input for Nickel RTD temperature sensor Ni1000, 6180 ppm/°C, range -50 to +250°C	-50 to 100°C $\pm 0.2\% \text{ C}$ 100 to 250°C $\pm 0.2\%$ from reading	two-wire connection
K*	input for Platinum RTD temperature sensor Pt100, range -140 to +600°C	-140 to +100°C $\pm 0.2\% \text{ C}$ 100 to 600°C $\pm 0.2\%$ from reading	two-wire connection
K1*	input for Platinum RTD temperature sensor Pt1000, range -140 to +600°C	-140 to +100°C $\pm 0.2\% \text{ C}$ 100 to 600°C $\pm 0.2\%$ from reading	two-wire connection available also with sensors and transmitters
K3	precise input for RTD temperature sensor Pt1000, range -10 to +50°C	$\pm 0.06\% \text{ C}$	New ! Two-wire connection. Only galvanically not isolated. Available also with sensors.
N*	thermocouple K (NiCr-Ni) range -70 to +1300°C	$\pm(0.3\% + 1.5\% \text{ C})$ from reading	linearized, cold junction compensation
T*	thermocouple T (Cu-CuNi) range -200 to +400°C	$\pm(0.3\% + 1.5\% \text{ C})$ from reading	linearized, cold junction compensation
Q*	thermocouple J (Fe-Co) range -200 to +750°C	$\pm(0.3\% + 1.5\% \text{ C})$ from reading	linearized, cold junction compensation
P*	thermocouple S (Pt10%Rh-Pt), range 0 to +1700°C	$\pm(0.3\% + 1.5\% \text{ C})$ from reading from +200 to +1700°C	linearized, cold junction compensation
Q*	thermocouple B (Pt30%Rh-Pt), range +100 to +1800°C	$\pm(0.3\% + 1\% \text{ C})$ from reading from +300 to +1800°C	linearized, without cold junction compensation
S*	binary input for potential-less contact	maximum resistance of closed contact: 1000 ohms minimum duration for recording: 200ms	
S1	binary voltage input	voltage for „switched ON“ state: 3 to 30Vdc, input current in the „switched ON“ state: 1 to 9mA - depending on the applied voltage, minimum duration for indication of change: 200ms, galvanically isolated	
CTU	counter input for voltage signal	voltage for „HIGH“ state (for counter status change): 3 to 24Vdc, maximum pulse frequency 5kHz, backed-up operation, galvanically isolated	
CTK	counter input for potential-less contact and open collector	maximum pulse frequency 5kHz, programmable filter of pulse open collector ringing, backed-up operation during power mains failure, maximum resistance of closed contact: 10 kohms, minimum resistance of open contact: 250 kohms, galvanically unisolated	
FU	input for measurement of frequency voltage signal	0 to 5kHz, resolution 1Hz, accuracy $\pm(0.2\%$ from reading + 1Hz), input voltage for state "H": 3 to 24Vdc, input current in state "H": approximately 7mA, minimum duration of input impuls: 30us, galvanically isolated	
FK	input for measurement of frequency contact switching	0 to 5kHz, resolution 1Hz, accuracy $\pm(0.2\%$ from reading + 1Hz), maximum resistance of closed contact: 10 kohms, minimum resistance of open contact: 250 kohms, minimum duration of input pulse: 30us, galvanically unisolated	
RP	input for serial signal RS485 for devices supporting Modbus RTU or Advantech	E. g. measurement from Comet transmitters Tx4xx with RS485 digital output. Galvanically isolated. Maximum speed 115200Bd.	



UNIVERSAL MONITORING SYSTEM MS5D, MS5

PROGRAM FOR PERSONAL COMPUTER

Setting of all system parameters and the stored data processing is performed by the PC software for Windows.

- **Included software - freeware** is possible to download free from www.cometsystem.cz. It enables to communicate with logger through a serial RS232 link or through an RS485 network (long distance or several networked loggers), via USB, by means of modems (line or GSM) or via optional Ethernet interface. It also enables to configure the logger, read recorded values and display actual values of the inputs. It is possible to view and print recorded values in numeric format and export to dbf format for consequent analysis in any data processor (e.g. MS Excel). Free program version does not work with graphs.
- **Optional software** for Windows is also available. Program has all functions as free program. In addition optional software enables:
 - most complex graphic processing of recorded data including any zooming of time and vertical axes
 - on-line graphic visualization of curves with selectable refresh interval - the Display Mode
 - the Distant Display Mode on Internet/ Ethernet network
 - direct record of the Display Mode to the PC
 - automatic data download to the PC in preprogrammed intervals
 - automatic data export to the PC in preprogrammed intervals in dbf format
 - record of data to the network
 - administration of users and passwords
 - other functions

TECHNICAL PARAMETERS	
Memory type:	internal SRAM, backed-up by Lithium battery
Total memory capacity:	2MB (up to 480 000 values)
Logging mode:	noncyclic logging stops after filling the memory cyclic after filling memory oldest data is overwritten by new
Logging interval:	adjustable individually for all input channels from 1 second to 24 hours
Real time clock:	year, leap year, month, day, hour, minute, second, backed-up by Lithium battery
Input measured values (1 to 16 channels):	are defined for each channel by installed input modules (see table) accordingly to user requirements
AD converter (analog channels):	16 bits, conversion duration approximately 60ms/channel
Interfaces for communication with computer:	RS232 (RxD, TxD, RTS, CTS, GND), cable up to 15 m - included . Enables direct connection to the computer or via land line modem and GSM modem. USB interface - included RS485 - cable up to 1200 m, galvanically isolated, possibility of connection of several data loggers to one communication link - included
Supported communication speeds:	Ethernet interface LAN - optional 9600, 19200, 57600, 115200 Bd
Output for alarm indication:	1) Red LED at the side of the case, 32 LEDs - only MS5D data logger 2) Relay max. 8A/250Vac, switching-over contact 3) Voltage signal 0V/4.8V, maximum current 50mA, output designed for connection of external audio indication unit or telephone voice dialer 4) Alarm can be signalled also by e-mail message, SNMP trap, SMS - please see optional accessory
Power:	9 to 30Vdc, 24Vdc recommended
Operating temperature range:	0 to +50 °C
Dimensions including connectors:	215 x 225 x 60 mm
Protection:	IP20
Warranty:	2 years

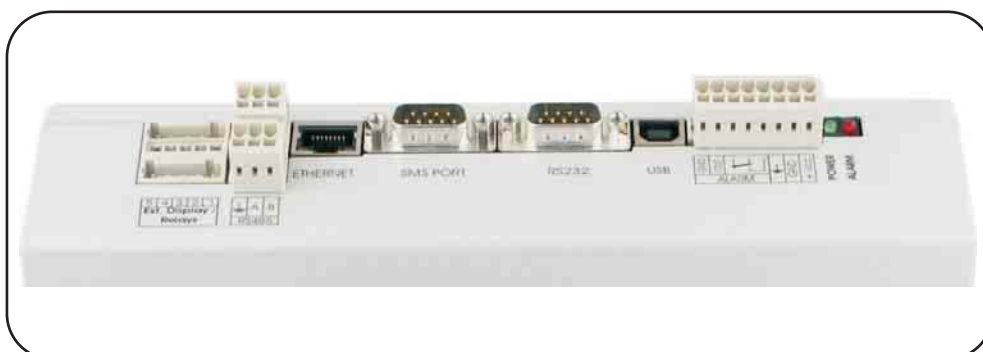

Power and communication connectors, alarm outputs



UNIVERSAL MONITORING SYSTEM MS5D, MS5

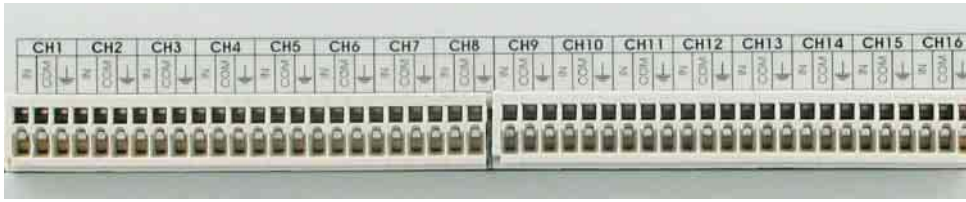

Terminals for input signal connection - each input has three terminals including shielding

Included accessory: Traceable calibration certificate from the manufacturer, instruction manual. Calibration certificate with declared metrological traceability of etalons is based on requirements of EN ISO/IEC 17025 standard. Included is also communication cable for RS232 2meters long, free Windows program (also downloadable for free from www.cometsystem.cz). Program enables to read recorded values and display actual values of the inputs. It is possible to view and print recorded values in numeric format and export to dbf format.

Optional accessory:

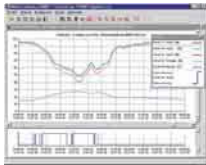

Accessories for data logger mounting:



SWR006

Optional software for Windows - comfort graphic environment data acquisition, including on-line graph, automatic data download, remote Display mode on Internet-Ethernet network, storing data on the network, administration of users and passwords and many others ..



MP013

Universal metal wall holders for data logger wall mounting. Package contains a pair of holders and 4 screws.



MP012

Holder for data logger mounting to DIN 35mm rail. Package contains the holder and 6 screws.

Power sources :



A1759

Universal ac/dc adapter 230V-50Hz/21Vdc/1A.



A1940

Universal ac/dc adapter 230V-50Hz/24Vdc/1A/24W for socket plug-in, switch-mode.



A5948

Power source 230V-50Hz/24Vdc/2,5A for DIN rail 35mm, dual terminals 24Vdc, switch-mode, including DIN rail of 100mm length.



UNIVERSAL MONITORING SYSTEM MS5D, MS5

Backup power supplies:



**A6963
supply**

**A7963
battery**

Backup power supply A6963, model MINI-DC-UPS/24DC/2 with battery A7963, model MINI-BAT/24DC/1.3AH, manufacturer Phoenix Contact. Power supply is designed for mounting to 35mm DIN rail in data logger case MP033 and MP034.

It contains two modules - UPS and battery. Included is a DIN rail for mounting to the case. Power supply is delivered uninstalled in original manufacturer packaging.

Backup power supply is able to supply data logger system with 200 mA consumption at least 3 hours, data logger system with 500 mA consumption at least 2 hours, data logger system with 1A consumption at least one hour. Discharged accumulators are recharged to full capacity in approximately 3 hours. System enables to inform user on switch-over to battery operation. More details are in Manual Appendixes.

For mounting to MP033 or MP034 case please order: 1pc A6963, 1pc A7963, 1pc MP035 rail.

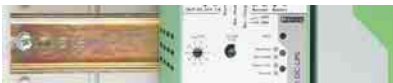

MP035

MP035 DIN rail 35mm of 226mm length with screws for mounting of A6963 power supply with A7963 battery to MP033 or MP034 case.



**A6966
supply**

**A7966
battery**

Backup power supply A6966, model AWZ224, manufacturer Pulsar sp.j., Poland. To this power supply it is necessary to buy two lead accumulators A7966 12V/7Ah in hermetical maintenance-free type of construction, e.g. type ELNIKA 12V/7.2Ah. Power supply is designed for mounting to vertical inflammable wall with sufficient air flow. Its protection rate is IP20. It is not designed for mounting to closed switchboard. This backup power supply is able to supply data logger with transmitters of current consumption 200mA for approximately 35 hours. Discharged accumulators are recharged to full capacity in approximately 14 hours. System enables to inform user on switch-over to battery operation. More details are in Manual Appendixes.

Please order: 1pc A6966, 2pcs A7966.



UNIVERSAL MONITORING SYSTEM

MS5D, MS5

Optional internal equipment:



MPO24

Built-in independent SMS port for GSM modem connection for SMS reception and sending. Enables to receive information from data logger by means of SMS messages - actual values, alarms, memory occupation and others - as a response to SMS query from user or in case of alarm creation at data logger. Not necessary, if data logger is connected to the PC via GSM modem.

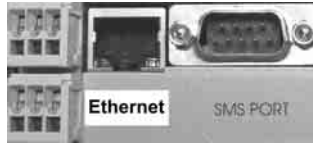

MPO25

Built-in LAN interface for data logger connection to Ethernet network. In case of limits exceeding alarm is activated and warning e-mail or SNMP trap are sent to specified addresses.

External communication converters:



MO021

Converter RS485/RS232 for serial port COMx at the PC side, including ac/dc adapter and terminator T485.



MPO22

Converter USB/RS485 for USB port at the PC side, including terminator T485. Powered from computer USB interface.

MPO23

Converter Ethernet/RS485 including ac/dc adapter and terminator T485. Designed for several data loggers connected via RS485 network for connection to the computer via Ethernet.

Accessories for ALARM OUT output:



MPO26

External audio indication unit. Enables to signal alarm state acoustically at the location up to 50m from data logger. Audio unit is connected to data logger by a cable (not included).

MPO02

Telephone voice dialer for alarm reporting, ac/dc adapter included. Enables in ALARM OUT output activity to send voice report to selected telephone numbers. Voice dialer is connected to land line.

Output relays module:

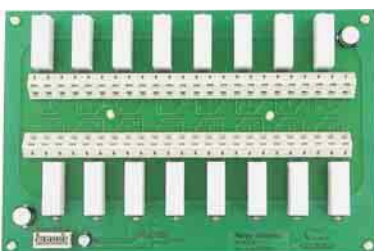









MPO18

Output relays module with interconnection cable. It contains 16 mains relays 250V/8A with switching-over contacts. Each relay can be controlled based on alarm creation at different input channels accordingly to setting of user program. Any relay can be assigned to any alarm at any input. Output relays are designed for external devices control (switching of heating, cooling, ventilation, distant alarm etc.). It is necessary to order connection cable to data logger MPO17, optionally other accessories.



UNIVERSAL MONITORING SYSTEM

MS5D, MS5

  	<p>MP017</p>	<p>Connection cable for terminal with display and output relays module - cable length approximately 60cm. Longer cable lengths available - maximum 2m for relay module.</p>
	<p>MP013</p>	<p>Universal metal wall holders for data logger wall mounting. Package contains a pair of holders and 4 screws.</p>
	<p>MP019</p>	<p>Holder for relay module mounting to DIN 35mm rail. Package contains the holder and 6 plastic rivets.</p>
	<p>MP020</p>	<p>DIN rail for relay module with elevated consoles for mounting to the MPO33, MPO34 case. Rail enables to raise the relay module enables to lead cables to data logger under the module.</p>
<p>Terminals with display:</p>		
	<p>MP016</p>	<p>Terminal with dual line alphanumeric LCD and control buttons and 32 alarm LEDs - for panel mounting or mounting to a case lid. Identical functions as built-in terminal of MS5D data logger. It is possible to build in with IP54 protection. Maximum cable length to data logger 50m. It is necessary to order the MPO17 connection cable to data logger.</p>
	<p>MP017</p>	<p>Connection cable for terminal with display - cable length approximately 60cm. Longer cable lengths available - maximum 50m.</p>
	<p>MP017-5</p>	<p>Connection cable for terminal with display - cable length 5m</p>
	<p>MP017-10</p>	<p>Connection cable for terminal with display - cable length 10m</p>
	<p>MP032</p>	<p>External terminal with dual line alphanumeric LCD and control buttons and 32 alarm LEDs - built in a IP54 protection case, including 2m cable with covered terminals. Identical functions as built-in terminal of MS5D data logger. Maximum cable length to data logger 50m.</p>
<p>GSM modem and accessories:</p>		
	<p>MP009</p>	<p>GSM modem WaveCom Fastrack Supreme, without accessories</p>
	<p>MP009/1</p>	<p>Antenna for GSM modem WaveCom Fastrack, right-angled</p>
	<p>MP009/2</p>	<p>Communication cable for GSM modem Fastrack</p>
	<p>MP009/3</p>	<p>Ac/dc adapter 230V/12V for GSM modem Fastrack</p>



UNIVERSAL MONITORING SYSTEM MS5D, MS5

Covers, cables and other accessories:



MP027

Covers of data logger terminals (pair). Designed for aesthetic covering of cables connected to terminals and connectors. Magnetic fixing to data logger.

MP007

USB connection cable A-B, 1,8m. Standard computer cable.

MP030

RS232 connector with terminals for RS232 interface connection by means of terminals, not by D-Sub connector.

MP031

Screwdriver for easy connection of cables to WAGO terminals

Assemblies in case with higher IP rate:



MP033

Case with IP65 protection with wall holders and data logger holders - no cutout in the lid. Dimensions 270 x 570 x 140 mm.



MP034

Data logger MS5 in IP54 protection case with connected terminal with display built in the lid. Dimensions 270 x 570 x 140 mm.

Temperature, humidity, pressure transmitters Comet are directly compatible with MS data loggers. Also complete monitoring system with data logger and transmitters can be delivered.