

INSTRUCTION MANUAL

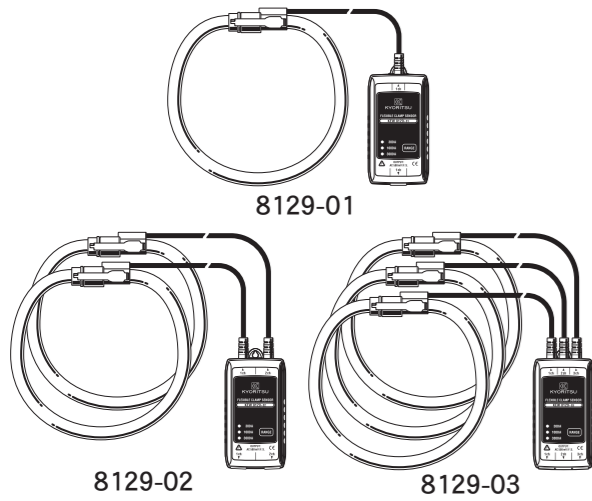

FLEXIBLE CLAMP SENSOR POWER CLAMP SENSOR Series KEW 8129 KYORITSU ELECTRICAL INSTRUMENTS WORKS, LTD.

1. SAFETY WARNINGS

This instrument has been designed and tested according to IEC61010: Safety Requirements for Electronic Measuring Apparatus, and delivered in the best condition after passing quality control tests. This instruction manual contains warnings and safety rules which have to be observed by the user to ensure safe operation of the instrument and to maintain it in safe condition. Therefore, read through these operating instructions before using the instrument.

- ⚠WARNING**
- Read through and understand instructions contained in this manual before using the instrument.
 - Keep the manual at hand to enable quick reference whenever necessary.
 - The instrument is to be used only in its intended applications.
 - Understand and follow all the safety instructions contained in the manual. It is essential that the above instructions are adhered to. Failure to follow the above instructions may cause injury, instrument damage and/or damage to equipment under test.

The symbol ⚠ indicated on the instrument, means that the user must refer to the related parts in the manual for safe operation of the instrument. It is essential to read the instructions wherever the ⚠ symbol appears in the manual.

- ⚠DANGER** is reserved for conditions and actions that are likely to cause serious or fatal injury.
- ⚠WARNING** is reserved for conditions and actions that can cause serious or fatal injury.
- ⚠CAUTION** is reserved for conditions and actions that can cause injury or instrument damage.

- ⚠DANGER**
- Never make measurement on a circuit in which the electrical potential exceeds AC600V.
 - Connect this instrument to the secondary side of a circuit breaker because the secondary side is protected by a breaker at accidental short-circuit. Do not make measurements at the primary side because Current capacitance at the primary side is quite big and serious damage may occur at accidental short-circuit.

- ⚠WARNING**
- Never attempt to make any measurement if any abnormal conditions, such as a broken cover or exposed metal parts are present on the instrument.
 - Do not disassemble, install substitute parts or make any modification to the instrument. Return the instrument to your local KYORITSU distributor for repair or re-calibration in case of suspected faulty operation.
 - Do not use the instrument if the instrument or your hands are wet. Otherwise, electrical shock accident may occur.
 - Use insulated protective gears for your safety when using this instrument.

- ⚠CAUTION**
- Do not step on or pinch the cord; it may damage the jacket of cord.
 - Do not expose the instrument to direct sunlight, high temperatures, humidity or dew. Otherwise, it may cause deformation or insulation degradation and cannot meet the original specification.
 - Not to give shocks, such as vibration or drop, which may damage the instrument, during transit or use.
 - Use a damp cloth with neutral detergent for cleaning the instrument. Do not use abrasives or solvents.
 - This instrument isn't waterproofed. Do not use it dusty places or where the instrument is likely to be wet. It may cause troubles on the instrument.
 - Never pinch foreign matters or give vibrations at the jointed parts of this instrument. Otherwise, matching area of Jaws may be damaged and cause influences on the measurements.
 - Do not bend or pull the root of the cable in order to prevent breaks in the cable.
 - Never apply the current exceeding measuring range for a long time. It may damage this instrument.
 - Never connect/remove the connectors while connected devices are on or clamping onto the conductor under test. Otherwise, connected devices or sensors may be damaged.
 - Accurate measurement may not be obtained in the vicinity of strong magnetic field such as transformers, high-current circuits or wireless machines.

Safety symbols

| | |
|--|---|
| | Refer to the instructions in the manual. |
| | Indicates a Instrument with double or reinforced insulation |
| | Must wear a insulated gears such as a pair of rubber gloves when connecting / disconnecting the sensor to / from live conductors. |
| | AC |

⚡ Measurement categories(Over-voltage categories)
To ensure safe operation of measuring instruments, IEC 61010 establishes safety standards for various electrical environments, categorized as CAT.I to CAT.IV, and called measurement categories. Higher-numbered categories correspond to electrical environments with greater momentary energy, so a measuring instrument designed for CAT.III environments can endure greater momentary energy than one designed for CAT.II.

CAT.I: Secondary electrical circuits connected to an AC electrical outlet through a transformer or similar device.

CAT.II: Primary electrical circuits of equipment connected to an AC electrical outlet by a power cord.

CAT.III: Primary electrical circuits of the equipment connected directly to the distribution panel, and feeders from the distribution panel to outlets.

CAT.IV: The circuit from the service drop to the service entrance, and to the power meter and primary overcurrent protection device(distribution panel).

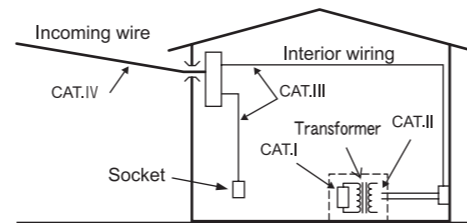

2. FEATURES

- This is a Clamp Sensor capable of measuring AC current up to 3000A.
- Flexible and light weight because of an air core coil used at the Sensor part
- One BOX contains measuring circuit for 3-channel. (8129-03)

3. INSTRUMENT LAYOUT

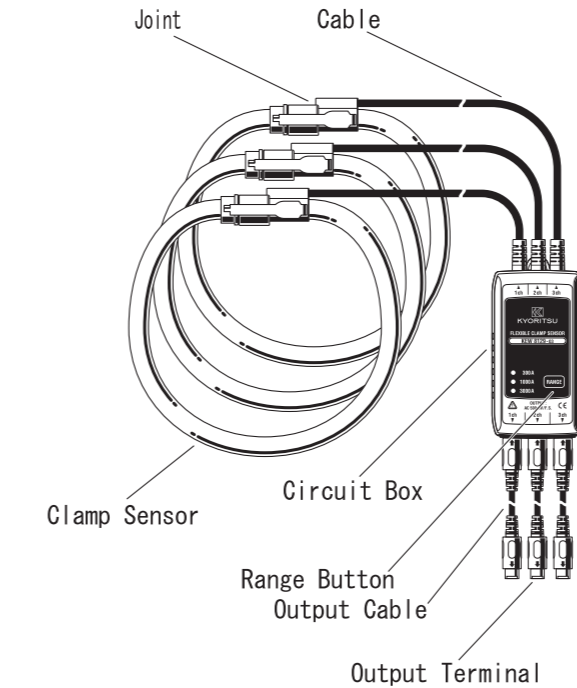

4. SPECIFICATION

| | |
|---|---|
| Model Name | 8129-01, -02, -03 |
| Rated current | 300A / 1000A / 3000A |
| Output voltage | 300A Range: AC500mV/AC300A(1.67mV/A) 1000A Range: AC500mV/AC1000A(0.5mV/A) 3000A Range: AC500mV/AC3000A(0.167mV/A) |
| Measuring range | 300A Range: 30 ~ 300Arms(424Apeak) 1000A Range: 100 ~ 1000Arms(1414Apeak) 3000A Range: 300 ~ 3000Arms(4243Apeak) |
| Accuracy (sine wave input) | ±1.0%rdg (45 ~ 65Hz) |
| Phase characteristics | within ±1° 300A Range: 30 ~ 300A(45 ~ 65Hz) 1000A Range: 100~1000A(45 ~ 65Hz) 3000A Range: 300 ~ 3000A(45 ~ 65Hz) |
| Current consumption (at power supply 3V) | 8129-01: 13mAtp. 8129-02: 14mAtp. 8129-03: 15mAtp. |
| Temperature & Humidity ranges (guaranteed accuracy) | 23°C±5°C, relative humidity 85%or less (no condensation) |
| Operating Temperature & Humidity ranges | 0 ~ 50°C, relative humidity 85%or less (no condensation) |
| Storage Temperature & Humidity ranges | -20 ~ 60°C, relative humidity 85%or less (no condensation) |
| Max allowable input | AC3600A continuous (45 ~ 65 Hz) |
| Output impedance | 100 Ω or less |
| Environmental condition | Altitude up to 2000m, in-door use |
| Applicable standards | IEC 61010-1, IEC 61010-2-032 Measurement CAT.III 600V Pollution degree 2 EMC : EN 61326 • EN 55022 • EN 61000-4-2 (performance criterion B) • EN 61000-4-3 (performance criterion B) |

| | |
|---------------------------|---|
| Withstand voltage | AC5350V (RMS value 50/60Hz) / for 5 sec between circuit and sensor |
| Insulation resistance | 50M Ω or more / 1000V between circuit and sensor |
| Measurable conductor size | max diameter 150mm |
| Dimension | 111(L) × 61(W) × 43 (D)mm (except for protrusions) |
| Cable length | Sensor part: approx 2m Output cable: approx 1m |
| Output terminal | MINI DIN 6PIN |
| Weight | 8129-01: approx 410g 8129-02: approx 680g 8129-03: approx 950g |
| Accessory | Instruction manual Output cable (M-7199) • 8129-01: 1pc • 8129-02: 2pcs • 8129-03: 3pcs Carrying Case (M-9137) |

DISTRIBUTOR

Kyoritsu reserves the rights to change specifications or designs described in this manual without notice and without obligations.

5. PIN ASSIGNMENT FOR OUTPUT TERMINAL & OUTPUT CONNECTOR

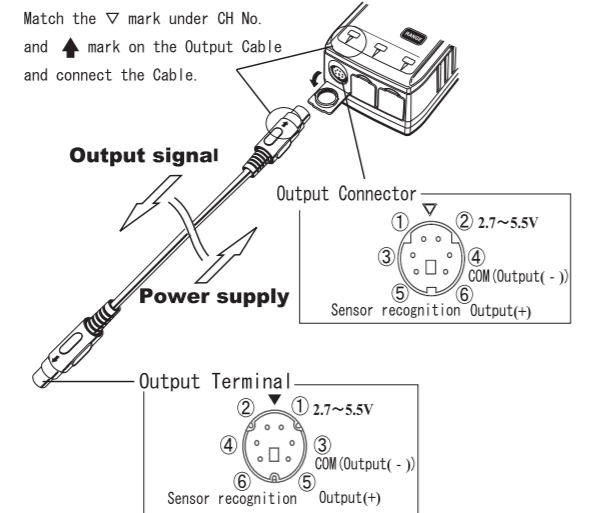

* Pin assignment at the connecting terminal of measuring instrument (MODEL6300, KEW5010 / 5020) is symmetrical to above figure.

* Output signal passes between 3 and 5 of Output terminal and between 4 and 6 of Output connector.

* This instrument is supplied power via an Output cable. Power supply of 2.7 ~ 5.5V (200mVA) is required between 1 and 3 of Output terminal and between 2 and 4 of Output connector.

* Resistance between 3 and 6 of Output terminal and between 4 and 5 of Output connector is as follows.
300A Range: 910kΩ, 1000A Range: 360kΩ, 3000A Range: 510kΩ
(Resistance cannot be measured while the instrument is powered off status.)

6. OPERATING INSTRUCTIONS

Note

- Jointed part of the Clamp sensor may be disconnected if excessive force is applied to. Insert pins in the Joint-fixing-hole to ensure a firm connection. (see the illustration below)
- Use non-conductive pin for fixing the Joint in order to avoid getting an electrical shock.
- Clamp onto one conductor only; measurements cannot be made when clamping single-phase (2-wire) or three-phase (3-wire) at the same time.

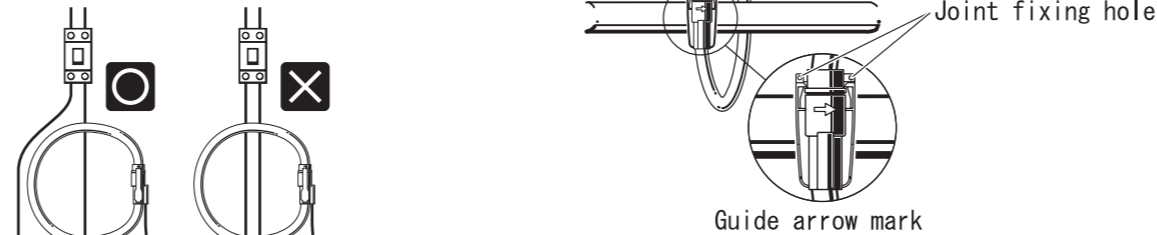

6-1 Measuring method

- (1) Connect the Output terminal to the Input terminal on the measuring unit (KEW5010/5020 Logger, 6300 Power meter etc...)
- (2) Power on the measuring unit.
- (3) Press the Joint according to the following illustrations and unlock it.

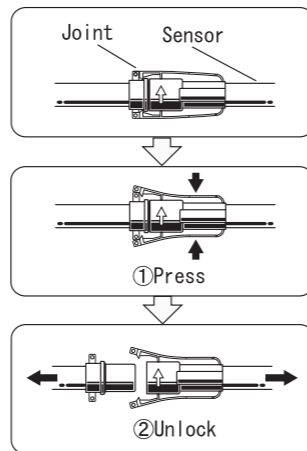

- (4) Clamp onto one conductor under the test. Locate the conductor at the center of the Clamp sensor. When connecting the Sensor with our Power meter (MODEL6300 etc.), check the direction of the Guide arrow mark indicating the current flowing direction marked on the Joint of the Clamp sensor to make the phase of the current under test and output voltage synchronized.

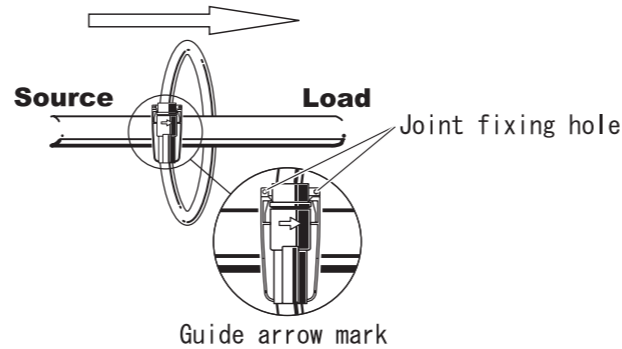

- (5) Confirm that the Joint on the Clamp sensor is firmly locked.
- (6) Select any desirable range (300A / 1000A / 3000A) with the RANGE Button. When powering off the instrument once and powering on again, the range will be the one selected before powering off the instrument.

6-2 Connecting with KEW5010 / 5020 Logger

When using this sensor together with our KEW5010 / 5020 Logger;

- (1) Connect the sensor to CH1 of KEW5010 / 5020 (if CH1 is used, connect to CH2) while KEW5010 / 5020 is in powered off status.
- (2) Then power on KEW5010 / 5020. Time is displayed, and a message of "LOAD" and selected range are displayed. Sensor type and a proper range are automatically recognized and selected when powering on the Logger.
- (3) Now the instrument is ready for measurements. When "LE" (no connection) is displayed on the LCD; it means no Sensor is connected to the selected channel or connection is loose. In this case, check the connection and reconnect the sensor, and power off KEW5010 / 5020. Then power it on again.
* Some KEW5010 / 5020 may not be used with these sensors. "LE" is displayed on the LCD of KEW5010 / 5020 after powering it on with sensors connected.

* To change ranges, press the RANGE Button on the sensor and select a proper range, and then power off KEW5010 / 5020, and power on again. Following illustrates how to change 3000A range to 1000A range.

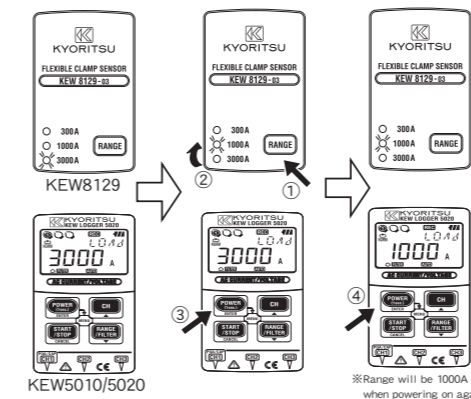

- ① Press the RANGE Button on the sensor to select any desirable range.
- ② LED for 1000A range will light up.
- ③ Power off KEW5010 / 5020.
- ④ Power it on again, and confirm the lighting LED on the sensor and the indication on the LCD of KEW5010 / 5020 are corresponding each other.

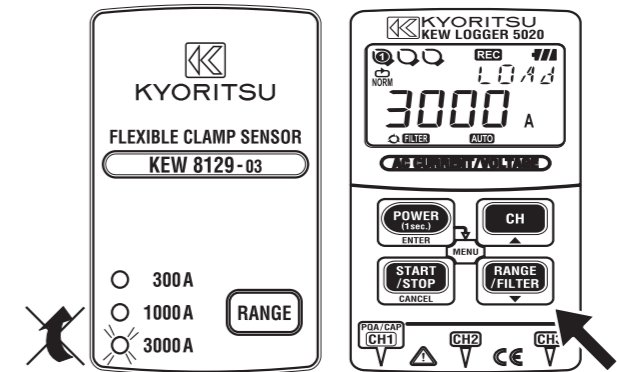

* Range of the sensor cannot be changed via the RANGE Button on KEW5010 / 5020.
* The RANGE Button on KEW5010 / 5020 switches Filter function on / off.

6-3 Setting on MODEL6300 Power Meter

When using this instrument together with our Power meter, MODEL6300, setting for the type of Clamp and available Current ranges on MODEL6300 are as follows.

(For the details of setting procedure, please refer to the instruction manual for MODEL6300.)

| Setting on MODEL6300 | |
|-----------------------------------|-----------------------------|
| Type of Clamp sensor (SETUP : 04) | Current range (SET UP : 03) |
| 3000A | 1000A / 3000A |

* Range of 300A at KEW8129 isn't available when using the sensor with MODEL6300.

* MODEL6300 differs from KEW5010/5020 and doesn't recognize the type of Sensor or ranges when it is powered on; above setting is required for precise measurements.

< Result view on MODEL6300 >
The [CT] Mark is displayed on the LCD of MODEL6300 when using 3000A range.

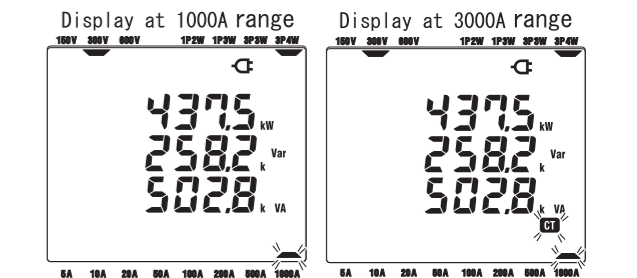

PEWA Messtechnik GmbH
Weidenweg 21
58239 Schwerte
Tel.: 02304-96109-0
Fax: 02304-96109-88
E-Mail: info@pewa.de
Homepage : www.pewa.de

K&S Elektronik **MB-electronic**