

421D Laser Distance Meter

Quick Reference Guide

Safety

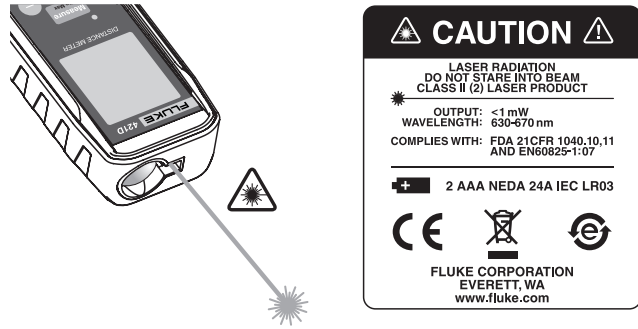

On/Off

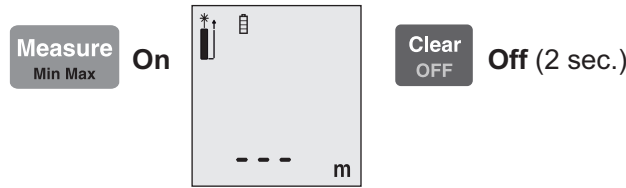

Batteries

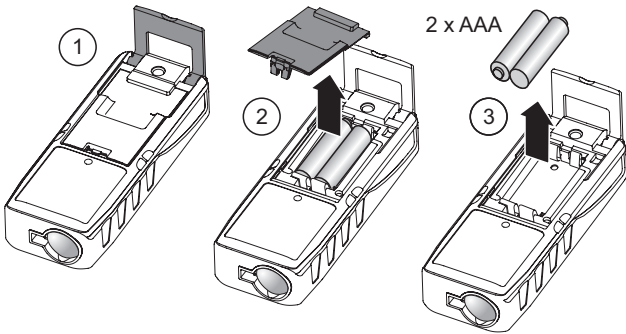

Display / Keyboard

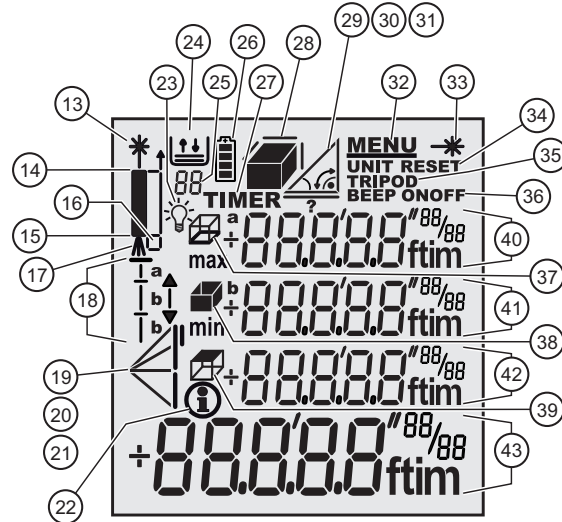
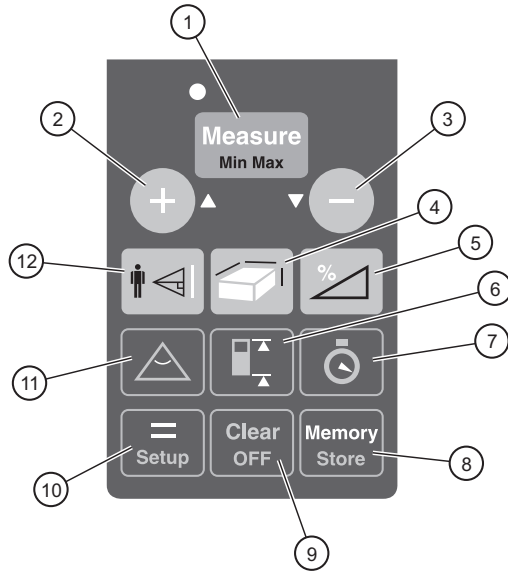

	English	Français	Deutsch	Español	Português	简体中文
1	Measure / Min Max / Power On	Mesure / Min Max / Allumage	Messung / Min Max / Ein	Medición / Mín. Máx. / Encendido	Medição / Mín. Máx. / Ligar	测量 / 最小、最大 / 通电
2	Plus (+) / scroll up	Plus (+) / Défilement haut	Plus (+) / Aufwärts blättern	Más (+) / Desplazamiento arriba	Mais (+) / Deslocar para cima	加 (+) / 上卷
3	Minus (-) / scroll down	Moins (-) / Défilement bas	Minus (-) / Abwärts blättern	Menos (-) / Desplazamiento abajo	Menos (-) / Deslocar para baixo	减 (-) / 下卷
4	Area / volume	Surface / Volume	Fläche / Volumen	Superficie / Volumen	Área / Volume	面积 / 体积
5	Tilt function / stake out	Fonction inclinaison / piquetage	Neigungsfunktion / Abstecken	Función de inclinación / Replanteo	Função de inclinação / Implantação	倾斜功能 / 立桩
6	Reference	Référence	Referenz	Referencia	Referência	基准
7	Timer	Minuterie	Zeitgeber	Temporizador	Temporizador	计时器
8	Memory	Mémoire	Speicher	Memoria	Memória	存储器
9	Clear / off	Effacement / extinction	Löschen / Aus	Borrar / apagar	Apagar / desligado	清除 / 关闭
10	Setup / mem / equal	Configuration / mémoire / égale	Einrichten / Speicher / Gleich	Configuración / mem. / igual	Configuração / mem. / igual	设置 / 存储 / 等于
11	Room corner / triangle angles	Angles de coin de pièce / triangle	Raumecke / Dreieckswinkel	Esquina de habitación / ángulos de triángulo	Canto da sala / ângulos do triângulo	房间角 / 三角形的角
12	Indirect measurement (Pythagoras)	Mesure indirecte (Pythagore)	Indirekte Messung (Pythagoras)	Medición indirecta (Pitágoras)	Medição indirecta (teorema de Pitágoras)	间接测量 (勾股定律)
13	Laser active	Laser actif	Laser aktiv	Láser activo	Laser activado	激光开启
14	Reference (front)	Référence de mesure (avant)	Messeebene (vorne)	Plano de medición (delante)	Referência (frente)	测量基准边 (前沿)
15	Reference (rear)	Référence de mesure (arrière)	Messeebene (hinten)	Plano de medición (detrás)	Referência (trás)	测量基准边 (后沿)
16	Reference (corner stop)	Référence de mesure (butée d'angle)	Messeebene (Eckanschlag)	Plano de medición (esquina)	Referência (paragem de canto)	测量基准边 (拐角)
17	Measuring with the tripod	Mesure avec trépied	Messen mit Stativ	Medición con trípode	Medição com tripé	用三脚架测量
18	Stake out function	Fonction de piquetage	Absteckfunktion	Función replanteo	Função de implantação	放样功能
19	Single Pythagorean measurement	Mesure de Pythagore simple	Einfache Pythagoras-Messung	Funciones de Pitágoras con dos mediciones	Medição simples com teorema de Pitágoras	单次利用勾股定律测量
20	Double Pythagorean measurement	Mesure de Pythagore double	Zweifache Pythagoras-Messung	Funciones de Pitágoras con tres mediciones	Medição dupla com teorema de Pitágoras	两次利用勾股定律测量
21	Double (partial height) measurement	Mesure double (hauteur partielle)	Zweifache (Teilstrecke)-Messung	Medición doble (altura parcial)	Medição dupla (altura parcial)	两次 (部分) 测量
22	Message code indicator	Témoin de code de message	Anzeigehinweis-Feld	Indicador de código de mensaje	Indicador do código da mensagem	消息代码指示符
23	Illumination	Eclairage	Beleuchtung	Iluminación	Iluminação	照明
24	Save constant value, call up constant value	Enregistrer la constante, appeler la constante	Konstante speichern, Konstante aufrufen	Memorizar constantes, acceso a las constantes	Guardar constante, chamar constante	储存常数, 调出常数
25	Historical memory, call up values	Mémoire historique, appel de valeurs	Historischer Speicher, Werte aufrufen	Memoria, acceso a los valores	Memória histórica, chamada de valores	历史储存, 调出数值
26	Battery status	Etat des piles	Batterieanzeige	Estado de las pilas	Estado de carga da bateria	电池状态
27	Timer	Minuterie	Zeitgeber	Temporizador	Temporizador	计时器
28	Area / volume	Surface / Volume	Fläche / Volumen	Superficie / Volumen	Área / Volume	面积 / 体积
29	Tilt	Inclinaison	Neigung	Inclinación	Inclinação	倾斜
30	Horizontal distance measurement using tilt	Mesure de distance horizontale à l'aide de l'inclinaison	Horizontaldistanzmessung mit Hilfe der Neigung	Medición de distancia horizontal con inclinación	Medição de distância horizontal com inclinação	利用倾斜测量水平距离
31	Room corner angle function	Fonction d'angle de pièce	Raumwinkelfunktion	Ángulo de esquina	Função de ângulo de canto de sala	房间角度功能
32	Menu	Menu	Menu	Menú	Menu	菜单
33	Continuous laser	Laser permanent	Dauerlaser	Medición continua	Laser contínuo	持续激光
34	Reset	Réinitialisation	Zurücksetzen	Restablecer	Reactivação	复位
35	Reference (tripod)	Référence de mesure (trépied)	Messeebene (Stativ)	Plano de medición (trípode)	Referência (tripé)	测量基准边 (三脚架)
36	Beep	Bip	Beep	Alarma acústica	Aviso acústico	蜂鸣
37	Circumference	Périmètre	Umfang	Circunferencia	Circunferência	周长
38	Wall area	Surface murale	Wandfläche	Superficie del muro	Área de parede	墙面面积
39	Ceiling area	Surface de plafond	Deckenfläche	Superficie del techo	Área de tecto	天花板面积
40	Intermediate line 1	Interligne 1	Zwischenzeile 1	Línea intermedia 1	Linha intermédia 1	辅助显示 1
41	Intermediate line 2	Interligne 2	Zwischenzeile 2	Línea intermedia 2	Linha intermédia 2	辅助显示 2
42	Intermediate line 3	Interligne 3	Zwischenzeile 3	Línea intermedia 3	Linha intermédia 3	辅助显示 3
43	Summary line	Ligne principale	Hauptzeile	Línea de resumen	Linha de sumário	主显示栏

Setup

2 sec. 1.1 = **UNIT**

2.1 = **UNIT**

3.1 = **BEEP**

4.1 = **Laser**

5.1 = **TRIPOD**

6.1 = **LIGHT**

7.1 = **RESET**

+ Δ OR ▽ -

Changes settings in submenu

2 sec.

Saves all changed settings

Clear OFF

Exit menu without changes

Stop Bracket

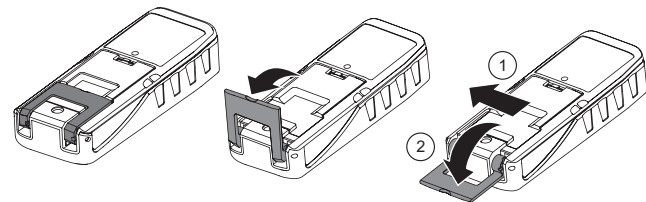
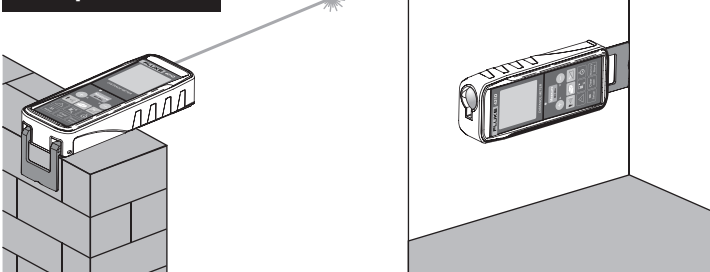

+ Add

Measure Min Max 1x

0.920 m

+ Δ

Measure Min Max 1x

0.920 m

+ 2.949 m

= Setup 1x

0.920 m

- 2.949 m

= 3.869 m

- Subtract

Measure Min Max 1x

7.463 m

▽ -

Measure Min Max 1x

7.463 m

- 5.407 m

= Setup 1x

7.463 m

- 5.407 m

= 2.056 m

Distance / Reference Point

Measure Min Max

--- m

+

Measure Min Max

--- m

=

3.721 m

Measure Min Max

--- m

+

Measure Min Max

--- m

=

0.872 m

Measure Min Max

--- m

+

Measure Min Max

--- m

=

1.392 m

Corner Angle

1x =

α = ?

Angle

1x =

Max. +45°

Min. -45°

Obstacle

2x =

Continuous / MIN-MAX Measurement

Measure Min Max 1x

--- m

+

Measure Min Max 1x (2 sec.)

--- m

--- m

(1 sec.)

1.271 m

1.184 m

1.207 m

MIN

1.222 m

0.998 m

1.051 m

MAX

3.229 m

2.881 m

3.143 m

3.229 m

Area

1x =

Measure Min Max 1x

2.539 m

4.860 m

12.339 m²

2

Measure Min Max 1x

2.539 m

4.860 m

12.339 m²

2 Sec. =

Volume

2x =

Measure Min Max 1x

2.677 m

9.948 m

22.289 m³

1

Measure Min Max 1x

2.677 m

9.948 m

22.289 m³

2

Measure Min Max 1x

2.677 m

9.948 m

22.289 m³

3

2 Sec. =

Stakeout

3x =

a = b

0.625 m

0.625 m

0.625 m

1

2

3

a ≠ b

1.025 m

0.625 m

0.625 m

1

2

3

Height

1x =

2x =

3x =

1

2

3

1

2

3

1

2

3

Memory

Memory Store 2 sec.

Save constant

Clear OFF + Memory Store 2 sec.

Delete history

Memory Store 1x

Recall constant

Memory Store 2x

History (1-20)