

## Instruction Manual

---

# HI 83211

## Multiparameter Bench Photometer for Chemical Manufacturers

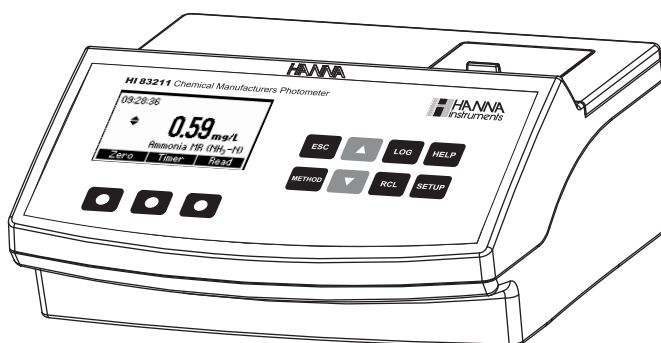

Dear Customer,

Thank you for choosing a Hanna product. Please read this instruction manual carefully before using the instrument. This manual will provide you with the necessary information for the correct use of the instrument. If you need additional technical information, do not hesitate to e-mail us at [tech@hannainst.com](mailto:tech@hannainst.com).

## TABLE OF CONTENTS

PRELIMINARY EXAMINATION .....	3	CYANURIC ACID .....	31
ABBREVIATIONS .....	3	IODINE .....	33
GENERAL DESCRIPTION .....	3	IRON HR .....	35
SPECIFICATIONS .....	4	IRON LR .....	37
PRECISION AND ACCURACY .....	4	MOLYBDENUM .....	40
PRINCIPLE OF OPERATION .....	4	NICKEL HR .....	43
FUNCTIONAL DESCRIPTION .....	6	NICKEL LR .....	45
TIPS FOR AN ACCURATE MEASUREMENT .....	8	pH .....	48
HEALTH & SAFETY .....	11	PHOSPHATE HR .....	50
METHOD REFERENCE TABLE .....	11	PHOSPHATE LR .....	52
OPERATIONAL GUIDE .....	12	PHOSPHORUS .....	54
SETUP .....	14	SILICA .....	56
HELP MODE .....	16	SILVER .....	58
ALUMINIUM .....	17	ZINC .....	61
AMMONIA MR .....	19	ERRORS AND WARNINGS .....	63
AMMONIA LR .....	21	DATA MANAGEMENT .....	64
CHROMIUM VI HR .....	23	STANDARD METHODS .....	65
CHROMIUM VI LR .....	25	ACCESSORIES .....	66
COPPER HR .....	27	WARRANTY .....	67
COPPER LR .....	29	HANNA LITERATURE .....	67

*All rights are reserved. Reproduction in whole or in part is prohibited without the written consent of the copyright owner, Hanna Instruments Inc., Woonsocket, Rhode Island, 02895, USA.*

## PRELIMINARY EXAMINATION

Please examine this product carefully. Make sure that the instrument is not damaged. If any damage occurred during shipment, please notify your local Hanna Office.

Each meter is supplied complete with:

- Four Sample Cuvettes and Caps
- Cloth for wiping cuvettes (1 pcs)
- Scissors
- AC/DC Power Adapter
- Instruction Manual

**Note:** Save all packing material until you are sure that the instrument works correctly. Any defective item must be returned in its original packing with the supplied accessories.

## ABBREVIATIONS

EPA:	US Environmental Protection Agency
°C:	degree Celsius
°F:	degree Fahrenheit
µg/L:	micrograms per liter (ppb)
mg/L:	milligrams per liter (ppm)
g/L:	grams per liter (ppt)
mL:	milliliter
HR:	high range
MR:	medium range
LR:	low range
PAN:	1-(2-pyridylazo)-2-naphthol
TPTZ:	2,4,6-tri-(2-pyridyl)-1,3,5-triazine

## GENERAL DESCRIPTION

**HI 83211** is a multiparameter bench photometer dedicated for chemical manufacturers analysis. It measures 21 different methods using specific liquid or powder reagents. The amount of reagent is precisely dosed to ensure maximum reproducibility.

**HI 83211** bench photometer can be connected to a PC via an USB cable. The optional **HI 92000** Windows® Compatible Software helps users manage all their results.

**HI 83211** has a powerful interactive user support that assists the user during the analysis process.

Each step in the measurement process is help supported. A tutorial mode is available in the Setup Menu.

## SPECIFICATIONS

<b>Light Life</b>	Life of the instrument
<b>Light Detector</b>	Silicon Photocell
<b>Environment</b>	0 to 50°C (32 to 122°F); max 90% RH non-condensing
<b>Power Supply</b>	external 12 Vdc power adapter built-in rechargeable battery
<b>Dimensions</b>	235 x 200 x 110 mm (9.2 x 7.87 x 4.33")
<b>Weight</b>	0.9 Kg

For specifications related to each method (e.g. range, resolution, etc.) refer to the related measurement section.

## PRECISION AND ACCURACY

Precision is how closely repeated measurements agree with each other. Precision is usually expressed as standard deviation (SD).

Accuracy is defined as the nearness of a test result to the true value.

Although good precision suggests good accuracy, precise results can be inaccurate. The figure explains these definitions.

For each method, the accuracy is expressed in the related measurement section.

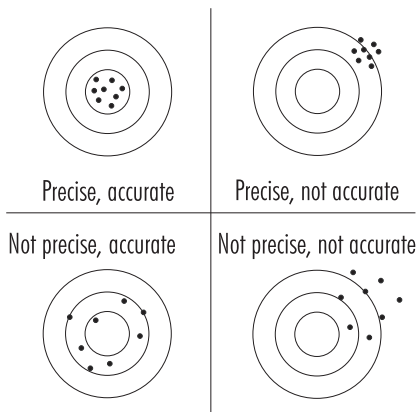

## PRINCIPLE OF OPERATION

Absorption of light is a typical phenomenon of interaction between electromagnetic radiation and matter. When a light beam crosses a substance, some of the radiation may be absorbed by atoms, molecules or crystal lattices.

If pure absorption occurs, the fraction of light absorbed depends both on the optical path length through the matter and on the physical-chemical characteristics of substance according to the Lambert-Beer Law:

$$-\log \frac{I}{I_0} = \epsilon_{\lambda} c d$$

or

$$A = \epsilon_{\lambda} c d$$

Where:

- $-\log I/I_0 =$  Absorbance (A)
- $I_0 =$  intensity of incident light beam
- $I =$  intensity of light beam after absorption
- $\epsilon_\lambda =$  molar extinction coefficient at wavelength  $\lambda$
- $c =$  molar concentration of the substance
- $d =$  optical path through the substance

Therefore, the concentration "c" can be calculated from the absorbance of the substance as the other factors are known.

Photometric chemical analysis is based on the possibility to develop an absorbing compound from a specific chemical reaction between sample and reagents.

Given that the absorption of a compound strictly depends on the wavelength of the incident light beam, a narrow spectral bandwidth should be selected as well as a proper central wavelength to optimize measurements.

The optical system of **HI 83211** is based on special subminiature tungsten lamps and narrow-band interference filters to guarantee both high performance and reliable results.

Five measuring channels allow a wide range of tests.

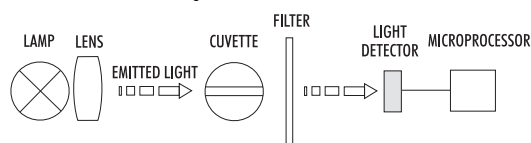

Instrument block diagram (optical layout)

A microprocessor controlled special tungsten lamp emits radiation which is first optically conditioned and beamed through the sample contained in the cuvette. The optical path is fixed by the diameter of the cuvette. Then the light is spectrally filtered to a narrow spectral bandwidth, to obtain a light beam of intensity  $I_0$  or  $I$ . The photoelectric cell collects the radiation  $I$  that is not absorbed by the sample and converts it into an electric current, producing a potential in the mV range.

The microprocessor uses this potential to convert the incoming value into the desired measuring unit and to display it on the LCD.

The measurement process is carried out in two phases: first the meter is zeroed and then the actual measurement is performed.

The cuvette has a very important role because it is an optical element and thus requires particular attention. It is important that both the measurement and the calibration (zeroing) cuvette are optically identical to provide the same measurement conditions. Most methods use the same cuvette for both, so it is important that measurements are taken at the same optical point. The instrument and the cuvette cap have special marks that must be aligned in order to obtain better reproducibility.

The surface of the cuvette must be clean and not scratched. This is to avoid measurement interference due to unwanted reflection and absorption of light. It is recommended not to touch the cuvette walls with hands.

Furthermore, in order to maintain the same conditions during the zeroing and the measurement phases, it is necessary to cap the cuvette to prevent any contamination.

## FUNCTIONAL DESCRIPTION



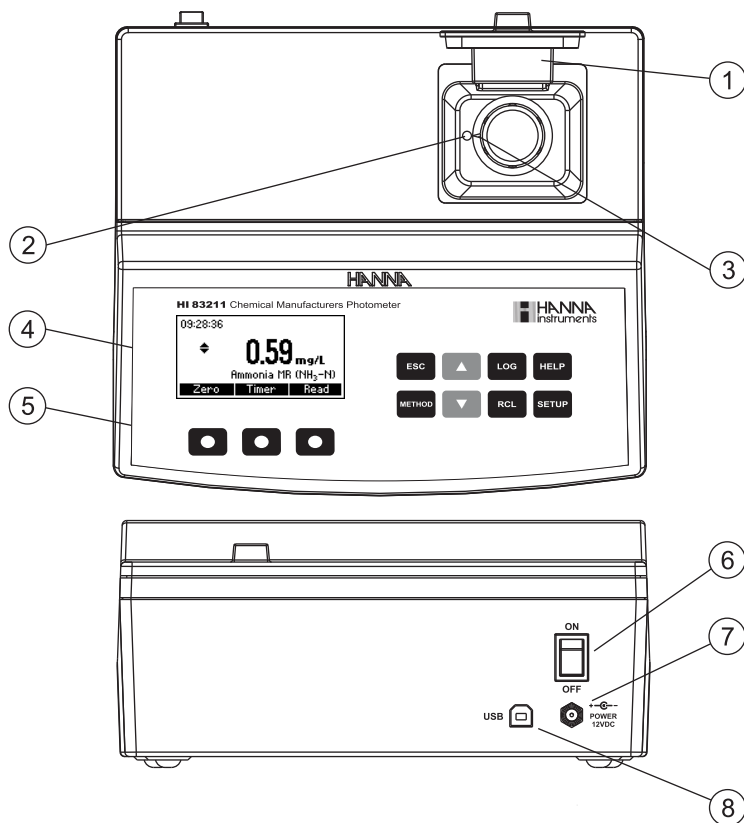





### INSTRUMENT DESCRIPTION



- 1) Open Cuvette Lid
- 2) Indexing mark
- 3) Cuvette point
- 4) Liquid Crystal Display (LCD)
- 5) Splash proof keypad
- 6) ON/OFF power switch
- 7) Power input connector
- 8) USB connector

## KEYPAD DESCRIPTION

The keypad contains 8 direct keys and 3 functional keys with the following functions:

-  Press to perform the function displayed above it on the LCD.
-  Press to exit the current screen.
-  Press to access the select method menu.
-  Press to move up in a menu or a help screen, to increment a set value, to access second level functions.
-  Press to move down in a menu or a help screen, to decrement a set value, to access second level functions.
-  Press to log the current reading.
-  Press to recall the log.
-  Press to display the help screen.
-  Press to access the setup screen.

## TIPS FOR AN ACCURATE MEASUREMENT

The instructions listed below should be carefully followed during testing to ensure most accurate results.

- Color or suspended matter in large amounts may cause interference, and should be removed by treatment with active carbon and filtration.
- Ensure the cuvette is filled correctly: the liquid in the cuvette forms a convexity on the top; the bottom of this convexity must be at the same level as the 10 mL mark.

### COLLECTING AND MEASURING SAMPLES

- In order to measure exactly 0.5 mL of reagent with the 1 mL syringe:
  - (a) push the plunger completely into the syringe and insert the tip into the solution.
  - (b) pull the plunger up until the lower edge of the seal is exactly on the 0.0 mL mark.
  - (c) take out the syringe and clean the outside of the syringe tip. Be sure that no drops are hanging on the tip of the syringe, if so eliminate them. Then, keeping the syringe in vertical position above the cuvette, push the plunger down into the syringe until the lower edge of the seal is exactly on the 0.5 mL mark. Now the exact amount of 0.5 mL has been added to the cuvette, even if the tip still contains some solution.

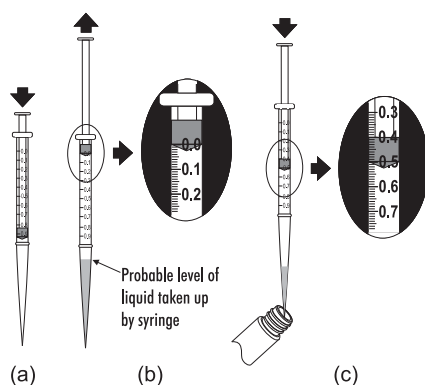

### USING LIQUID AND POWDER REAGENTS

- Proper use of the dropper:
  - (a) for reproducible results, tap the dropper on the table for several times and wipe the outside of the dropper tip with a cloth.
  - (b) always keep the dropper bottle in a vertical position while dosing the reagent.





- Proper use of the powder reagent packet:
  - (a) use scissors to open the powder packet;
  - (b) push the edges of the packet to form a spout;
  - (c) pour out the content of the packet.

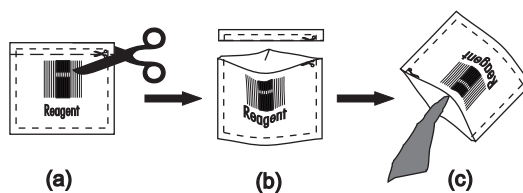

### USING CUVETTES

- Proper mixing is very important for reproducibility of the measurements. The right way of mixing a cuvette is specified for each method in the related chapter.
  - (a) **invert the cuvette** a couple of times or for a specified time: hold the cuvette in the vertical position. Turn the cuvette upside-down and wait for all of the solution to flow to the cap end, then return the cuvette to the upright vertical position and wait for all of the solution to flow to the cuvette bottom. This is one inversion. The correct speed for this mixing technique is 10-15 complete inversions in 30 seconds.

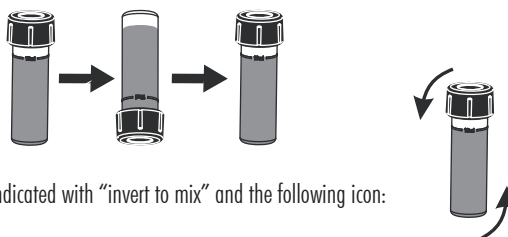

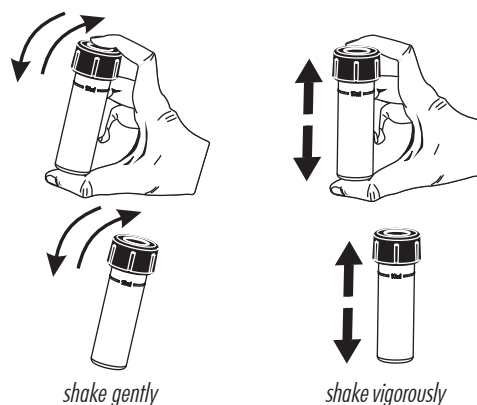

This mixing technique is indicated with “invert to mix” and the following icon:

- (b) **shaking the cuvette**, moving the cuvette up and down. The movement may be gentle or vigorous. This mixing method is indicated with “shake gently” or “shake vigorously”, and one of the following icons:

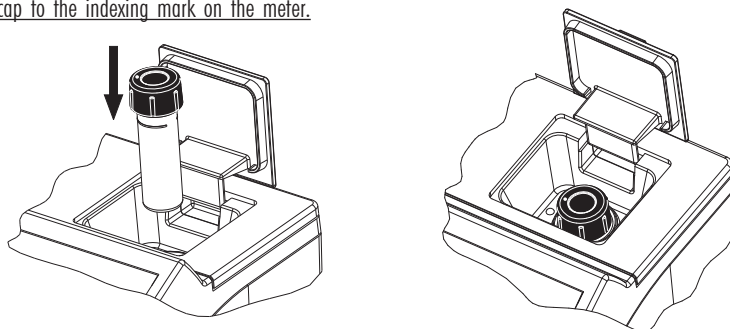

- Pay attention to push the cuvette completely down in the holder and to align the white point on the cap to the indexing mark on the meter.



- In order to avoid reagent leaking and to obtain more accurate measurements, close the cuvette first with the supplied HDPE plastic stopper  and then the black cap.
- Each time the cuvette is used, the cap must be tightened to the same degree.
- Whenever the cuvette is placed into the measurement cell, it must be dry outside, and free of fingerprints, oil or dirt. Wipe it thoroughly with **HI 731318** or a lint-free cloth prior to insertion.
- Shaking the cuvette can generate bubbles in the sample, causing higher readings. To obtain accurate measurements, remove such bubbles by swirling or by gently tapping the cuvette.
- Do not let the reacted sample stand too long after reagent is added. For best accuracy, respect the timings described in each specific method.
- It is possible to take multiple readings in a row, but it is recommended to take a new zero reading for each sample and to use the same cuvette for zeroing and measurement when possible (for most precise results follow the measurement procedures carefully).
- Discard the sample immediately after the reading is taken, or the glass might become permanently stained.
- All the reaction times reported in this manual are at 25 °C (77 °F). In general, the reaction time should be increased for temperatures lower than 20 °C (68 °F), and decreased for temperatures higher than 25 °C (77 °F).

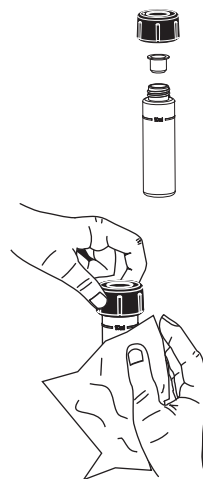

## **INTERFERENCES**

- In the method measurement section the most common interferences that may be present in an average sample matrix have been reported. It may be that for a particular treatment process other compounds do interfere with the method of analysis.

## HEALTH & SAFETY



- The chemicals contained in the reagent kits may be hazardous if improperly handled.
- Read the Material Safety Data Sheet (MSDS) before performing tests.
- Safety equipment: Wear suitable eye protection and clothing when required, and follow instructions carefully.
- Reagent spills: If a reagent spill occurs, wipe up immediately and rinse with plenty of water. If reagent contacts skin, rinse the affected area thoroughly with water. Avoid breathing released vapors.
- Waste disposal: for proper disposal of reagent kits and reacted samples, refer to the Material Safety Data Sheet (MSDS).

## METHOD REFERENCE TABLE

Method	Method description	Page
1	Aluminum	17
2	Ammonia MR	19
3	Ammonia LR	21
4	Chromium VI HR	23
5	Chromium VI LR	25
6	Copper HR	27
7	Copper LR	29
8	Cyanuric Acid	31
9	Iodine	33
10	Iron HR	35
11	Iron LR	37

Method	Method description	Page
12	Molybdenum	40
13	Nickel HR	43
14	Nickel LR	45
15	pH	48
16	Phosphate HR	50
17	Phosphate LR	52
18	Phosphorus	54
19	Silica	56
20	Silver	58
21	Zinc	61

## OPERATIONAL GUIDE

### POWER CONNECTION AND BATTERY MANAGEMENT

The meter can be powered from an AC/DC adapter (included) or from the built-in rechargeable battery.

**Note:** Always turn the meter off before unplugging it to ensure no data is lost.

When the meter switches ON, it verifies if the power supply adapter is connected. The battery icon on the LCD will indicate the battery status:

- battery is charging from external adapter
- battery fully charged (meter connected to AC/DC adapter)

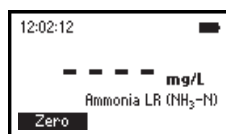
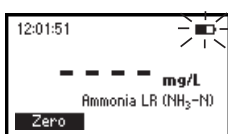

- battery capacity (no external adapter)
- battery Low (no external adapter)

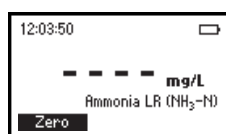
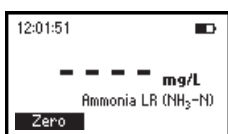

- battery Dead (no external adapter)

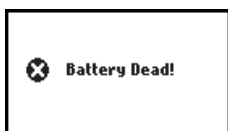

### METHOD SELECTION

- Turn the instrument ON via the ON/OFF power switch.
- The meter will perform an autodiagnostic test. During this test, the Hanna Instrument logo will appear on the LCD. After 5 seconds, if the test was successful, the last method used will appear on the display.
- In order to select the desired method press the **METHOD** key and a screen with the available methods will appear.
- Press the ▲ ▼ keys to highlight the desired method. Press **Select**.

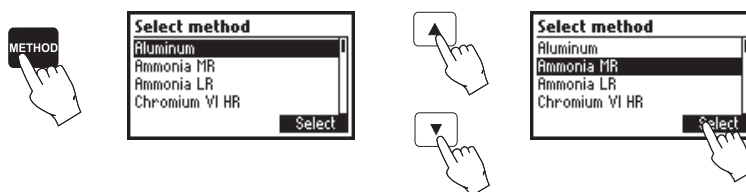

- After the desired method is selected, follow the measurement described in the related section.
- Before performing a test you should read all the instructions carefully.

### DATA MANAGEMENT

The instrument features a data log function to help you keep track of all your analysis. The data log can hold 200 individual measurements. Storing, viewing and deleting the data is possible using the **LOG** and **RCL** keys.

*Storing data:* You can store only a valid measurement. Press **LOG** and the last valid measurement will be stored with date and time stamps.

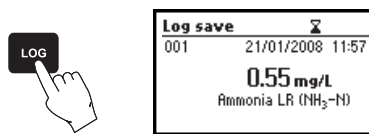

*Viewing and deleting:* You can view and delete the data log by pressing the **RCL** key. You can only delete the last saved measurement. Additionally, you can delete the data records all at once.

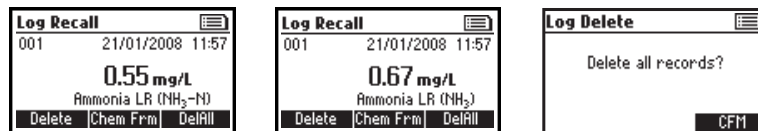

### CHEMICAL FORM

Chemical form conversion factors are pre-programmed into the instrument and are method specific. In order to view the displayed result in the desired chemical form press **▲** or **▼** to access the second level function and then press the **Chem Frm** key to toggle between the available chemical forms for the selected method.

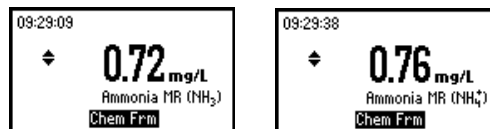

## SETUP

In the Setup mode the instrument's parameters can be changed. Some parameters affect the measuring sequence and others are general parameters that change the behavior or appearance of the instrument.

Press **SETUP** to enter the setup mode.

Press **ESC** or **SETUP** to return to the main screen.

A list of setup parameters will be displayed with currently configured settings. Press **HELP** for additional information.

Press the **▲ ▼** keys to select a parameter and change the value as follows:



### Backlight

**Values:** 0 to 8.

Press the **Modify** key to access the backlight value.

Use the **◀ ▶** functional keys or the **▲ ▼** keys to increase or decrease the value.

Press the **Accept** key to confirm or **ESC** to return to the setup menu without saving the new value.

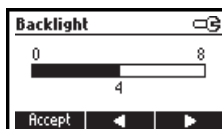
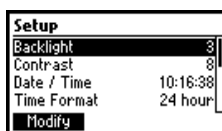

### Contrast

**Values:** 0 to 20.

This option is used to set the display's contrast.

Press the **Modify** key to change the display's contrast.

Use the **◀ ▶** functional keys or the **▲ ▼** keys to increase or decrease the value.

Press the **Accept** key to confirm the value or **ESC** to return to the setup menu without saving the new value.

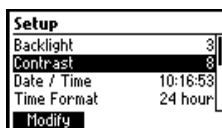

## Date / Time

This option is used to set the instrument's date and time.

Press the **Modify** key to change the date/time.

Press the ◀ ▶ functional keys to highlight the value to be modified (year, month, day, hour, minute or second). Use the ▲ ▼ keys to change the value.

Press the **Accept** key to confirm or **ESC** to return to the setup without saving the new date or time.

## Time format

**Option:** AM/PM or 24 hour.

Press the functional key to select the desired time format.

## Date format

Press the **Modify** key to change the Date Format.

Use the ▲ ▼ keys to select the desired format.

Press **Accept** key to confirm or **ESC** to return to the setup menu without saving the new format.

## Language

Press the corresponding key to change the language.

If the new language cannot be loaded, the previously selected language will be reloaded.

## Tutorial

**Option:** Enable or Disable.

If enabled this option will provide the user short guide related to the current screen.

Press the functional key to enable/disable the tutorial mode.

## Beeper

**Option:** Enable or Disable.

When enabled, a short beep is heard every time a key is pressed. A long beep alert sounds when the pressed key is not active or an error is detected.

Press the functional key to enable/disable the beeper.

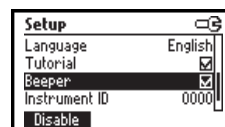
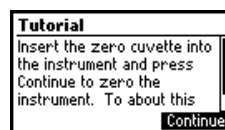
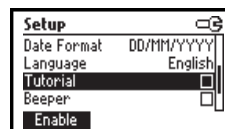
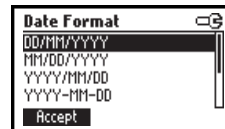
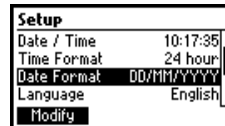
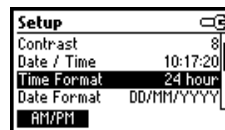
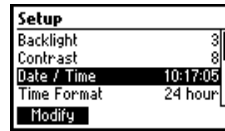

## Instrument ID

Option: 0 to 9999.

This option is used to set the instrument's ID (identification number). The instrument ID is used while exchanging data with a PC.

Press the **Modify** key to access the instrument ID screen. Press the **▲ ▼** keys in order to set the desired value.

Press the **Accept** key to confirm the value or **ESC** to return to the setup menu without saving the new value.

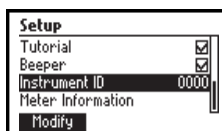

## Meter information

Press the **Select** key to view the instrument model, firmware version, language version and instrument serial number.

Press **ESC** to return to the Setup mode.

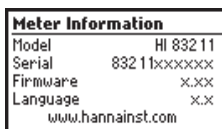
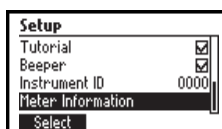

## HELP MODE

HI 83211 offers an interactive contextual help mode that assists the user at any time.

To access the help screens press **HELP**.

The instrument will display additional information related to the current screen. To read all the available information, scroll the text using the **▲ ▼** keys.

Press the **Support** key to access a screen with Hanna service centers and their contact details.

Press the **Accessories** key to access a list of instrument reagents and accessories.

To exit support or accessories screens press **ESC** and the instrument will return to the previous help screen.

To exit help mode press the **HELP** or **ESC** key again and the meter will return to the previously selected screen.

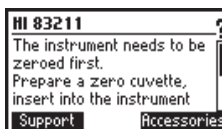



## ALUMINUM

### SPECIFICATIONS

Range	0.00 to 1.00 mg/L
Resolution	0.01 mg/L
Accuracy	$\pm 0.02$ mg/L $\pm 4\%$ of reading at 25 °C
Typical EMC	$\pm 0.01$ mg/L
Deviation	
Light Source	Tungsten lamp with narrow band interference filter @ 525 nm
Method	Adaptation of the aluminon method. The reaction between aluminum and reagents causes a reddish tint in the sample.

### REQUIRED REAGENTS

Code	Description	Quantity
HI 93712A-0	Ascorbic acid	1 packet
HI 93712B-0	Aluminon reagent	1 packet
HI 93712C-0	Bleaching powder	1 packet

### REAGENT SETS

HI 93712-01 Reagents for 100 tests

HI 93712-03 Reagents for 300 tests

For other accessories see page 66.

### MEASUREMENT PROCEDURE

- Select the *Aluminum* method using the procedure described in the *Method Selection* section (see page 12).
- Fill a graduated beaker with 50 mL of sample.
- Add the content of one packet of HI 93712A-0 Ascorbic acid and mix until completely dissolved.
- Add the content of one packet of HI 93712B-0 Aluminon reagent and mix until completely dissolved. This is the sample.
- Fill two cuvettes with 10 mL of sample each (up to the mark).

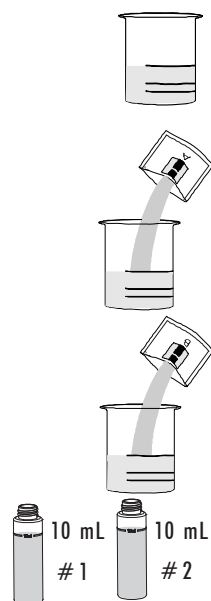

Aluminum

- Add the content of one packet of HI 93712C-0 Bleaching powder to one of the two cuvettes. Replace the cap and shake vigorously until completely dissolved. This is the blank.

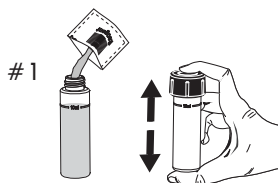

- Place the blank into the holder and close the lid.
- Press **Timer** and the display will show the countdown prior to zeroing the blank. Alternatively wait for 15 minutes and then press **Zero**. The display will show “-0.0-” when the meter is zeroed and ready for measurement.

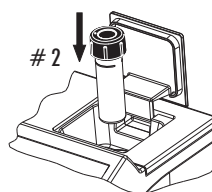
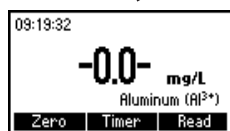
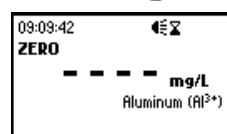
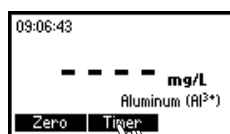
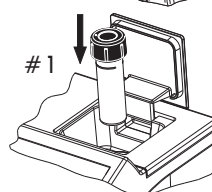

- Remove the blank and insert the other cuvette into the instrument.
- Press the **Read** key and the meter will perform the reading. The instrument displays the results in mg/L of aluminum.

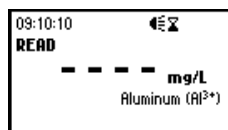
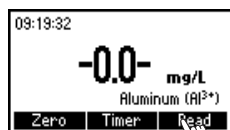

- Press ▲ or ▼ to access the second level functions.
- Press the **Chem Frm** key to convert the result in mg/L of Al<sub>2</sub>O<sub>3</sub>.

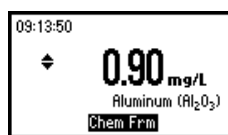

- Press ▲ or ▼ to return to the measurement screen.

### INTERFERENCES

Interference may be caused by:

Iron above 20 mg/L, Alkalinity above 1000 mg/L, Phosphate above 50 mg/L; Fluoride must be absent.

## AMMONIA MEDIUM RANGE

### SPECIFICATIONS

<b>Range</b>	0.00 to 10.00 mg/L
<b>Resolution</b>	0.01 mg/L
<b>Accuracy</b>	±0.05 mg/L ±5% of reading at 25 °C
<b>Typical EMC Deviation</b>	±0.01 mg/L
<b>Light Source</b>	Tungsten lamp with narrow band interference filter @ 420 nm
<b>Method</b>	Adaptation of the <i>ASTM Manual of Water and Environmental Technology, D1426-92</i> , Nessler method. The reaction between ammonia and reagents causes a yellow tint in the sample.

### REQUIRED REAGENTS

<u>Code</u>	<u>Description</u>	<u>Quantity</u>
HI 93715A-0	First Reagent	4 drops (6 drops for seawater)
HI 93715B-0	Second Reagent	4 drops (10 drops for seawater)

### REAGENT SETS

HI 93715-01 Reagents for 100 tests

HI 93715-03 Reagents for 300 tests

For other accessories see page 66.

### MEASUREMENT PROCEDURE

- Select the *Ammonia MR* method using the procedure described in the *Method Selection* section (see page 12).
- Fill the cuvette with 10 mL of unreacted sample (up to the mark) and replace the cap.
- Place the cuvette into the holder and close the lid.
- Press the **Zero** key. The display will show “-0.0-” when the meter is zeroed and ready for measurement.

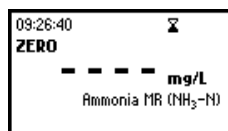
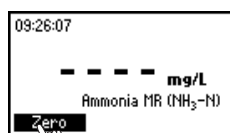
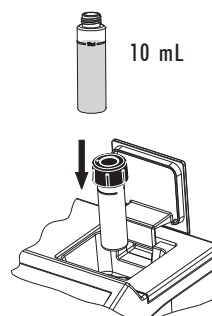

- Remove the cuvette.
- Add 4 drops of HI 93715A-0 First Reagent (6 drops for seawater analysis). Replace the cap and mix the solution.
- Add 4 drops of HI 93715B-0 Second Reagent (10 drops for seawater analysis). Replace the cap and mix the solution.
- Reinsert the cuvette into the instrument.
- Press **Timer** and the display will show the countdown prior to the measurement or, alternatively, wait for 3 minutes and 30 seconds and press **Read**. When the timer ends the meter will perform the reading. The instrument displays the results in **mg/L of ammonia nitrogen (NH<sub>3</sub>-N)**.

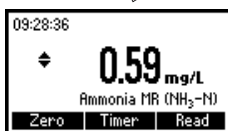
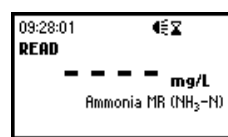
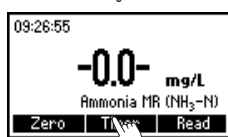
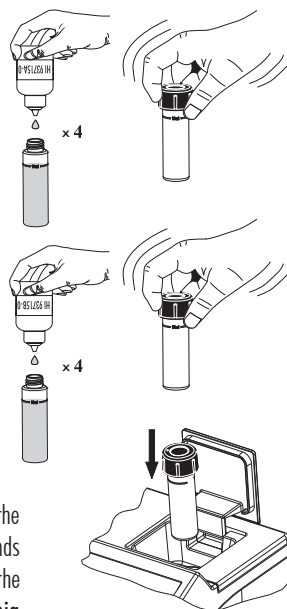

- Press **▲** or **▼** to access the second level functions.
- Press the **Chem Frm** key to convert the result in mg/L of ammonia (NH<sub>3</sub>) and ammonium (NH<sub>4</sub><sup>+</sup>).

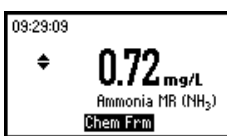
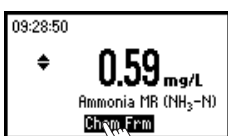

- Press **▲** or **▼** to return to the measurement screen.

## INTERFERENCES

Interference may be caused by:

acetone, alcohols, aldehydes, glycine, hardness above 1 g/L, iron, organic chloramines, sulfide, various aliphatic and aromatic amines.

## AMMONIA LOW RANGE

### SPECIFICATIONS

<b>Range</b>	0.00 to 3.00 mg/L
<b>Resolution</b>	0.01 mg/L
<b>Accuracy</b>	±0.04 mg/L ±4% of reading at 25 °C
<b>Typical EMC Deviation</b>	±0.01 mg/L
<b>Light Source</b>	Tungsten lamp with narrow band interference filter @ 420 nm
<b>Method</b>	Adaptation of the <i>ASTM Manual of Water and Environmental Technology, D1426-92</i> , Nessler method. The reaction between ammonia and reagents causes a yellow tint in the sample.

### REQUIRED REAGENTS

<u>Code</u>	<u>Description</u>	<u>Quantity</u>
HI 93700A-0	First Reagent	4 drops (6 drops for seawater)
HI 93700B-0	Second Reagent	4 drops (10 drops for seawater)

### REAGENT SETS

HI 93700-01 Reagents for 100 tests

HI 93700-03 Reagents for 300 tests

For other accessories see page 66.

### MEASUREMENT PROCEDURE

- Select the *Ammonia LR* method using the procedure described in the *Method Selection* section (see page 12).
- Fill the cuvette with 10 mL of unreacted sample (up to the mark) and replace the cap.
- Place the cuvette into the holder and close the lid.
- Press the **Zero** key. The display will show “-0.0-” when the meter is zeroed and ready for measurement.

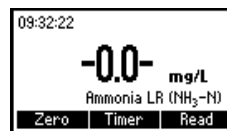
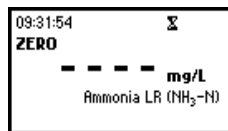
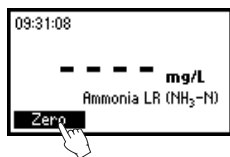
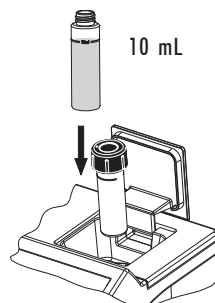

- Remove the cuvette.

- Add 4 drops of HI 93700A-0 First Reagent (6 drops for seawater analysis). Replace the cap and mix the solution.

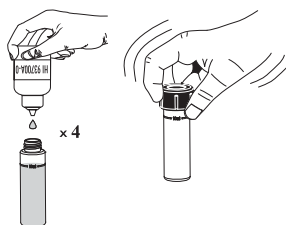

- Add 4 drops of HI 93700B-0 Second Reagent (10 drops for seawater analysis). Replace the cap and mix the solution.

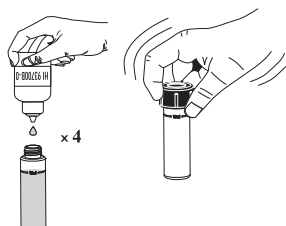

- Reinsert the cuvette into the instrument.

- Press **Timer** and the display will show the countdown prior to the measurement or, alternatively, wait for 3 minutes and 30 seconds and press **Read**. When the timer ends the meter will perform the reading. The instrument displays the results in **mg/L of ammonia nitrogen (NH<sub>3</sub>-N)**.

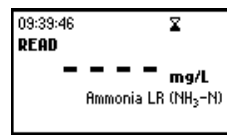
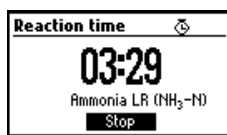
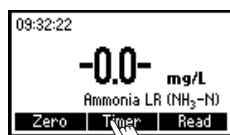
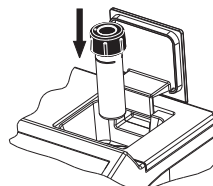

- Press ▲ or ▼ to access the second level functions.
- Press the **Chem Frm** key to convert the result in mg/L of ammonia (NH<sub>3</sub>) and ammonium (NH<sub>4</sub><sup>+</sup>).

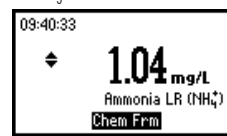
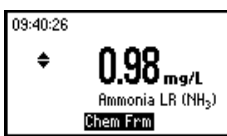
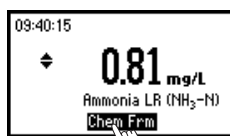

- Press ▲ or ▼ to return to the measurement screen.

### INTERFERENCES

Interference may be caused by: acetone, alcohols, aldehydes, glycine, hardness above 1 g/L, iron, organic chloramines, sulfide, various aliphatic and aromatic amines.

## CHROMIUM VI HIGH RANGE

### SPECIFICATIONS

Range	0 to 1000 µg/L
Resolution	1 µg/L
Accuracy	±5 µg/L ±4% of reading at 25 °C
Typical EMC Deviation	±1 µg/L
Light Source	Tungsten lamp with narrow band interference filter @ 525 nm
Method	Adaptation of the <i>ASTM Manual of Water and Environmental Technology, D1687-92</i> , Diphenylcarbohydrazide method. The reaction between chromium VI and the reagent causes a purple tint in the sample.

### REQUIRED REAGENTS

<u>Code</u>	<u>Description</u>	<u>Quantity</u>
HI 93723-0	Powder reagent	1 packet

### REAGENT SETS

HI 93723-01 Reagents for 100 tests

HI 93723-03 Reagents for 300 tests

For other accessories see page 66.

### MEASUREMENT PROCEDURE

- Select the *Chromium VI HR* method using the procedure described in the *Method Selection* section (see page 12).
- Fill the cuvette with 10 mL of unreacted sample (up to the mark) and replace the cap.
- Place the cuvette into the holder and close the lid.

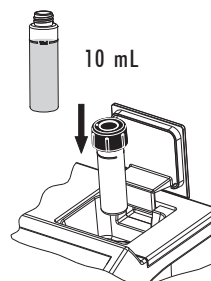

- Press the **Zero** key. The meter will show “-0.0-” when the meter is zeroed and ready for measurement.

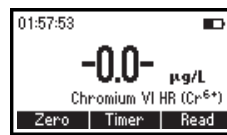
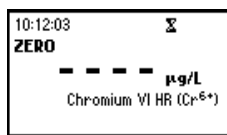
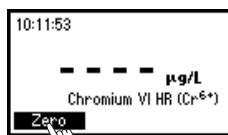

- Remove the cuvette and add the content of one packet of HI 93723-0 reagent. Replace the cap and shake vigorously for about 10 seconds.

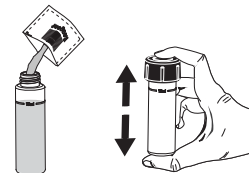

- Reinsert the cuvette into the instrument.

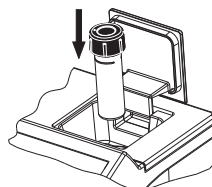

- Press **Timer** and the display will show the countdown prior to the measurement or, alternatively, wait for 6 minutes and press **Read**. When the timer ends the meter will perform the reading. The instrument displays concentration in  $\mu\text{g/L}$  of chromium VI.

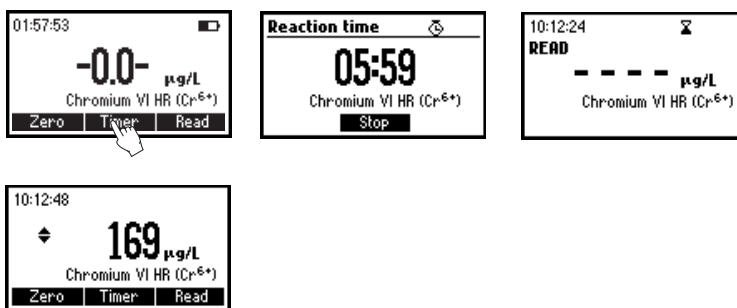

- Press  $\blacktriangle$  or  $\blacktriangledown$  to access the second level functions.
- Press the **Chem Frm** key to convert the result in  $\mu\text{g/L}$  of Chromate ( $\text{CrO}_4^{2-}$ ) and Dichromate ( $\text{Cr}_2\text{O}_7^{2-}$ ).

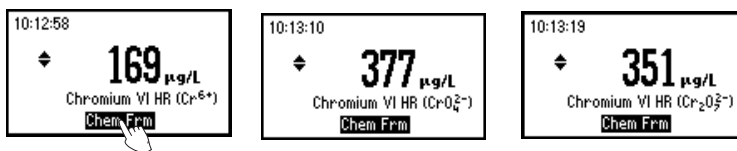

- Press  $\blacktriangle$  or  $\blacktriangledown$  to return to the measurement screen.

### INTERFERENCES

Interference may be caused by:

Vanadium above 1 ppm. However, waiting 10 minutes before reading, the interference is removed

Iron above 1 ppm

Mercurous and mercuric ions cause slight inhibition of the reaction.



## CHROMIUM VI LOW RANGE

### SPECIFICATIONS

<b>Range</b>	0 to 300 µg/L
<b>Resolution</b>	1 µg/L
<b>Accuracy</b>	±1 µg/L ±4% of reading at 25 °C
<b>Typical EMC</b>	±1 µg/L
<b>Deviation</b>	
<b>Light Source</b>	Tungsten lamp with narrow band interference filter @ 525 nm
<b>Method</b>	Adaptation of the <i>ASTM Manual of Water and Environmental Technology, D1687-92</i> , Diphenylcarbohydrazide method. The reaction between chromium VI and the reagent causes a purple tint in the sample.

### REQUIRED REAGENTS

Code	Description	Quantity
HI 93749-0	Powder reagent	1 packet

### REAGENT SETS

HI 93749-01 Reagents for 100 tests

HI 93749-03 Reagents for 300 tests

For other accessories see page 66.

### MEASUREMENT PROCEDURE

- Select the *Chromium VI LR* method using the procedure described in the *Method Selection* section (see page 12).
- Fill the cuvette with 10 mL of unreacted sample (up to the mark) and replace the cap.
- Place the cuvette into the holder and close the lid.
- Press the **Zero** key. The meter will show “-0.0-” when the meter is zeroed and ready for measurement.

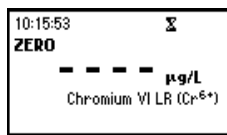
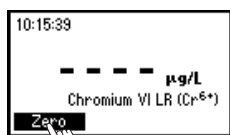
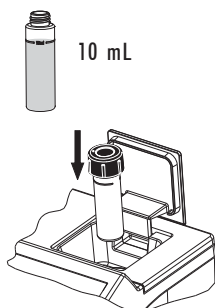

- Remove the cuvette and add the content of one packet of HI 93749-0 reagent. Replace the cap and shake vigorously for about 10 seconds.

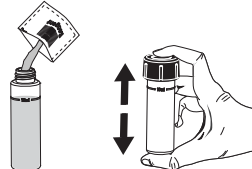

- Reinsert the cuvette into the instrument.

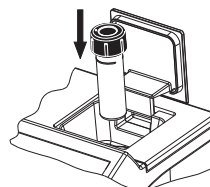

- Press **Timer** and the display will show the countdown prior to the measurement or, alternatively, wait for 6 minutes and press **Read**. When the timer ends the meter will perform the reading. The instrument displays concentration in **µg/L of chromium VI**.

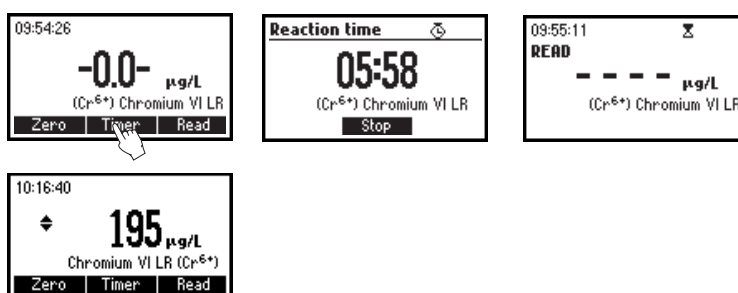

- Press **▲** or **▼** to access the second level functions.
- Press the **Chem Frm** key to convert the result in µg/L of Chromate ( $\text{CrO}_4^{2-}$ ) and Dichromate ( $\text{Cr}_2\text{O}_7^{2-}$ ).

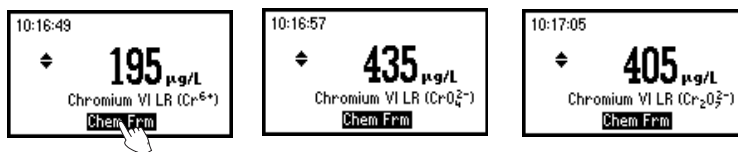

- Press **▲** or **▼** to return to the measurement screen.

### INTERFERENCES

Interference may be caused by:

Vanadium above 1 ppm. However, waiting 10 minutes before reading, the interference is removed.

Iron above 1 ppm

Mercurous and mercuric ions cause slight inhibition of the reaction.

## COPPER HIGH RANGE

### SPECIFICATIONS

<b>Range</b>	0.00 to 5.00 mg/L
<b>Resolution</b>	0.01 mg/L
<b>Accuracy</b>	±0.02 mg/L ±4% of reading at 25 °C
<b>Typical EMC</b>	±0.01 mg/L
<b>Deviation</b>	
<b>Light Source</b>	Tungsten lamp with narrow band interference filter @ 575 nm
<b>Method</b>	Adaptation of the <i>EPA method</i> . The reaction between copper and the bicinchoninate reagent causes a purple tint in the sample.

### REQUIRED REAGENTS

Code	Description	Quantity
HI 93702-0	Bicinchoninate	1 packet

### REAGENT SETS

HI 93702-01 Reagents for 100 tests  
 HI 93702-03 Reagents for 300 tests  
 For other accessories see page 66.

### MEASUREMENT PROCEDURE

- Select the *Copper HR* method using the procedure described in the *Method Selection* section (see page 12).
- Fill the cuvette with 10 mL of unreacted sample (up to the mark) and replace the cap.
- Place the cuvette into the holder and close the lid.

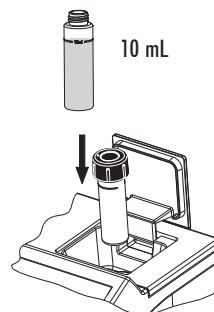

- Press the **Zero** key. The meter will show “-0.0-” when the meter is zeroed and ready for measurement.

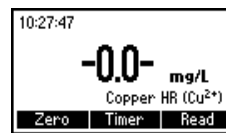
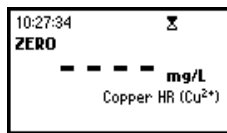
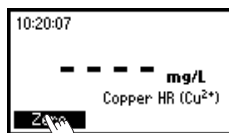

- Remove the cuvette.
- Add the content of one packet of HI 93702-0 Bicinchoninate. Replace the cap and shake gently for about 15 seconds.

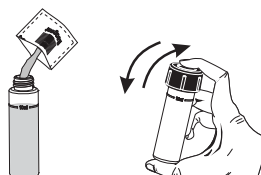

- Reinsert the cuvette into the instrument.

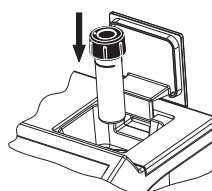

- Press **Timer** and the display will show the countdown prior to the measurement or, alternatively, wait for 45 seconds and press **Read**. When the timer ends the meter will perform the reading.

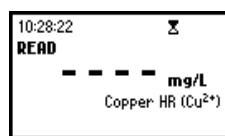
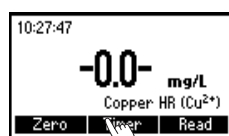

- The instrument displays the results in **mg/L** of copper.



### INTERFERENCES

Interference may be caused by:

Silver

Cyanide

For samples overcoming buffering capacity of reagent (around pH 6.8), pH should be adjusted between 6 and 8.

## COPPER LOW RANGE

### SPECIFICATIONS

<b>Range</b>	0 to 1000 µg/L
<b>Resolution</b>	1 µg/L
<b>Accuracy</b>	±10 µg/L ±5% of reading at 25 °C
<b>Typical EMC Deviation</b>	±1 µg/L
<b>Light Source</b>	Tungsten lamp with narrow band interference filter @ 575 nm
<b>Method</b>	Adaptation of the <i>EPA method</i> . The reaction between copper and the bicinchoninate reagent causes a purple tint in the sample.

### REQUIRED REAGENTS

Code	Description	Quantity
HI 95747-0	Bicinchoninate	1 packet

### REAGENT SETS

HI 95747-01 Reagents for 100 tests

HI 95747-03 Reagents for 300 tests

For other accessories see page 66.

### MEASUREMENT PROCEDURE

- Select the *Copper LR* method using the procedure described in the *Method Selection* section (see page 12).
- Fill the cuvette with 10 mL of unreacted sample (up to the mark) and replace the cap.
- Place the cuvette into the holder and close the lid.
- Press the **Zero** key. The meter will show “-0.0-” when the meter is zeroed and ready for measurement.

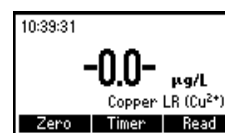
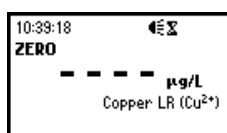
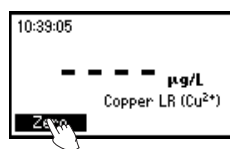
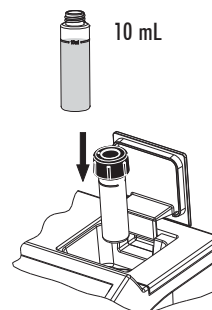

- Remove the cuvette.
- Add the content of one packet of HI 95747-0 Bicinchoninate. Replace the cap and shake gently for about 15 seconds.

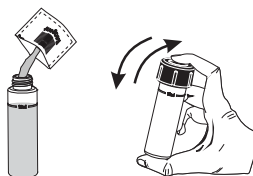

- Reinsert the cuvette into the instrument.

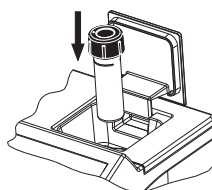

- Press **Timer** and the display will show the countdown prior to the measurement or, alternatively, wait for 45 seconds and press **Read**. When the timer ends the meter will perform the reading.

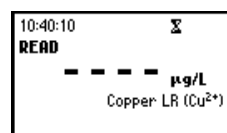
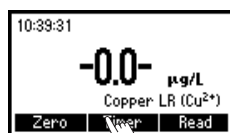

- The instrument displays the results in **µg/L** of copper.



### INTERFERENCES

Interference may be caused by:

Silver

Cyanide

For samples overcoming buffering capacity of reagent (around pH 6.8), pH should be adjusted between 6 and 8.

## CYANURIC ACID

### SPECIFICATIONS

<b>Range</b>	0 to 80 mg/L
<b>Resolution</b>	1 mg/L
<b>Accuracy</b>	$\pm 1$ mg/L $\pm 15\%$ of reading at 25 °C
<b>Typical EMC</b>	$\pm 1$ mg/L
<b>Deviation</b>	
<b>Light Source</b>	Tungsten lamp with narrow band interference filter @ 525 nm
<b>Method</b>	Adaptation of the turbidimetric method. The reaction between cyanuric acid and the reagent causes a white suspension in the sample.

### REQUIRED REAGENTS

Code	Description	Quantity
HI 93722-0	Powder reagent	1 packet

### REAGENT SETS

HI 93722-01 Reagents for 100 tests

HI 93722-03 Reagents for 300 tests

For other accessories see page 66.

### MEASUREMENT PROCEDURE

- Select the *Cyanuric Acid* method using the procedure described in the *Method Selection* section (see page 12).
- Fill the cuvette with 10 mL of unreacted sample (up to the mark) and replace the cap.
- Place the cuvette into the holder and close the lid.
- Press the **Zero** key. The meter will show “-0.0-” when the meter is zeroed and ready for measurement.

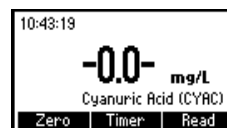
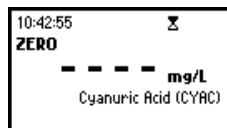
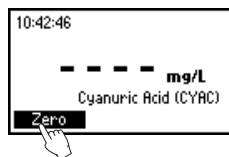
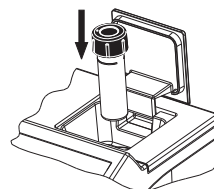

- Add the content of one packet of HI 93722-0 Cyanuric Acid Reagent. Replace the cap and shake gently for about 10 seconds (dissolution is not complete).

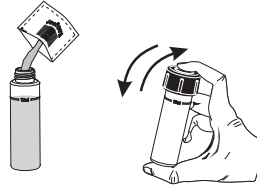

- Reinsert the cuvette into the instrument.

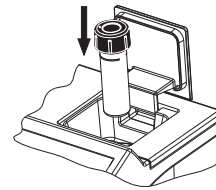

- Press **Timer** and the display will show the countdown prior to the measurement or, alternatively, wait for 45 seconds and press **Read**. When the timer ends the meter will perform the reading.

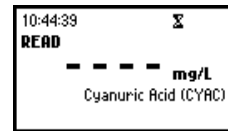

- The instrument displays concentration in mg/L of cyanuric acid.





## IODINE

### SPECIFICATIONS

<b>Range</b>	0.0 to 12.5 mg/L
<b>Resolution</b>	0.1 mg/L
<b>Accuracy</b>	±0.1 mg/L ±5% of reading at 25 °C
<b>Typical EMC</b>	±0.1 mg/L
<b>Deviation</b>	
<b>Light Source</b>	Tungsten lamp with narrow band interference filter @ 525 nm
<b>Method</b>	Adaptation of the <i>Standard Methods for the Examination of Water and Wastewater, 18<sup>th</sup> edition</i> , DPD method. The reaction between iodine and the reagent causes a pink tint in the sample.

### REQUIRED REAGENTS

<u>Code</u>	<u>Description</u>	<u>Quantity</u>
HI 93718-0	DPD Reagent	1 packet

### REAGENT SETS

HI 93718-01 Reagents for 100 tests

HI 93718-03 Reagents for 300 tests

For other accessories see page 66.

### MEASUREMENT PROCEDURE

- Select the *Iodine* method using the procedure described in the *Method Selection* section (see page 12).
- Fill the cuvette with 10 mL of unreacted sample (up to the mark) and replace the cap.
- Place the cuvette into the holder and close the lid.

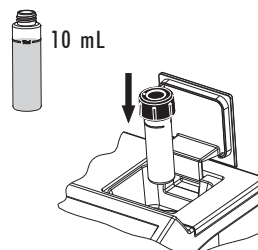

- Press the **Zero** key. The display will show “-0.0-” when the meter is zeroed and ready for measurement.

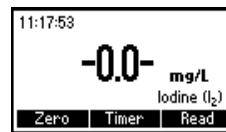
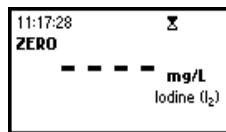
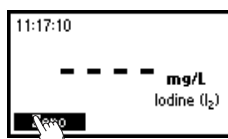

- Remove the cap and add the content of one packet of HI 93718-0 DPD reagent. Replace the cap and shake gently for about 30 seconds to dissolve most of the reagent.

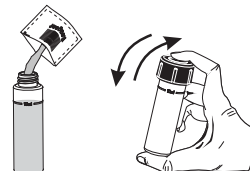

Iodine

- Reinsert the cuvette into the instrument.

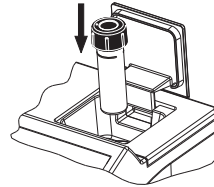

- Press **Timer** and the display will show the countdown prior to the measurement or, alternatively, wait for 2 minutes and 30 seconds and press **Read**. When the timer ends the meter will perform the reading.

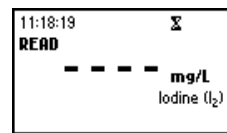
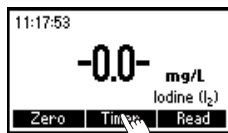

- The instrument displays concentration in **mg/L** of iodine.



### INTERFERENCES

Interference may be caused by: Bromine, Chlorine, Ozone, Oxidized forms of Chromium and Manganese. In case of water with hardness greater than 500 mg/L CaCO<sub>3</sub>, shake the sample for approximately 2 minutes after adding the reagent. In case of water with alkalinity greater than 250 mg/L CaCO<sub>3</sub> or acidity greater than 150 mg/L CaCO<sub>3</sub>, the color of the sample may develop only partially, or may rapidly fade. To resolve this, neutralize the sample with diluted HCl or NaOH.

## IRON HIGH RANGE

### SPECIFICATIONS

<b>Range</b>	0.00 to 5.00 mg/L
<b>Resolution</b>	0.01 mg/L
<b>Accuracy</b>	$\pm 0.04$ mg/L $\pm 2\%$ of reading at 25 °C
<b>Typical EMC Deviation</b>	$\pm 0.01$ mg/L
<b>Light Source</b>	Tungsten lamp with narrow band interference filter @ 525 nm
<b>Method</b>	Adaptation of the <i>EPA Phenantroline method 315B</i> , for natural and treated waters. The reaction between iron and reagents causes an orange tint in the sample.

### REQUIRED REAGENTS

<u>Code</u>	<u>Description</u>	<u>Quantity</u>
HI 93721-0	Powder Reagent	1 packet

### REAGENT SETS

HI 93721-01 Reagents for 100 tests

HI 93721-03 Reagents for 300 tests

For other accessories see page 66.

### MEASUREMENT PROCEDURE

- Select the *Iron HR* method using the procedure described in the *Method Selection* section (see page 12).
- Fill the cuvette with 10 mL of unreacted sample (up to the mark) and replace the cap.
- Place the cuvette into the holder and close the lid.

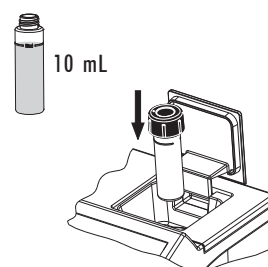

- Press the **Zero** key. The display will show “-0.0-” the meter is zeroed and ready for measurement.

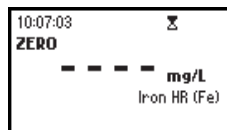
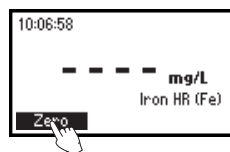

- Remove the cuvette and add the content of one packet of HI 93721-0 reagent. Replace the cap and shake until dissolution is complete.

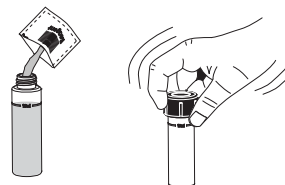

- Reinsert the cuvette into the instrument.

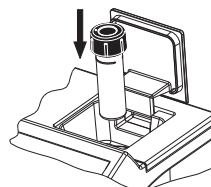

- Press **Timer** and the display will show the countdown prior to the measurement or, alternatively, wait for 3 minutes and press **Read**. When the timer ends the meter will perform the reading.

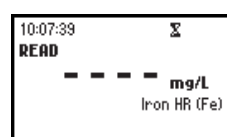
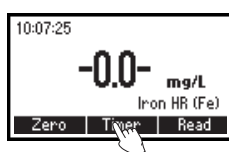

- The instrument displays concentration in **mg/L** of iron.

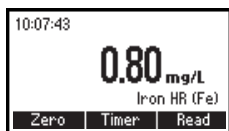

### INTERFERENCES

Interference may be caused by:

Molybdate Molybdenum above 50 ppm

Calcium above 10000 ppm (as CaCO<sub>3</sub>)

Magnesium above 100000 ppm (as CaCO<sub>3</sub>)

Chloride above 185000 ppm.

## IRON LOW RANGE

### SPECIFICATIONS

Range	0 to 400 $\mu\text{g/L}$
Resolution	1 $\mu\text{g/L}$
Accuracy	$\pm 10 \mu\text{g/L} \pm 8\%$ of reading at 25 °C
Typical EMC	$\pm 1 \mu\text{g/L}$
Deviation	
Light Source	Tungsten lamp with narrow band interference filter @ 575 nm
Method	Adaptation of the TPTZ Method. The reaction between iron and the reagent causes a violet tint in the sample.

### REQUIRED REAGENTS

Code	Description	Quantity
HI 93746-0	TPTZ Reagent	2 packets

### REAGENT SETS

HI 93746-01 Reagents for 50 tests

HI 93746-03 Reagents for 150 tests

For other accessories see page 66.

### MEASUREMENT PROCEDURE

- Select the *Iron LR* method using the procedure described in the *Method Selection* section (see page 12).
- Fill one graduated mixing cylinder up to the 25 mL mark with deionized water.
- Add the content of one packet of HI 93746-0 TPTZ reagent, close the cylinder and shake vigorously for 30 seconds. This is the blank.
- Fill a cuvette with 10 mL of the blank up to the mark and replace the cap.
- Place the cuvette into the holder and close the lid.

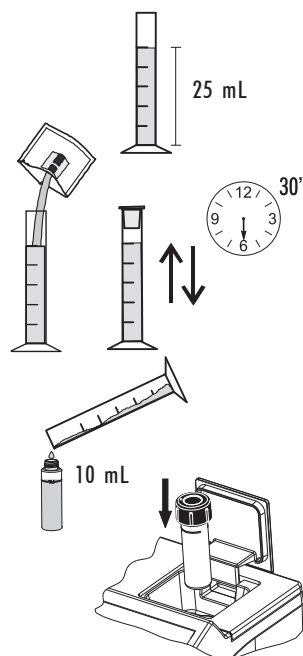

- Press the **Zero** key. The display will show “-0.0-” when the meter is zeroed and ready for measurement.

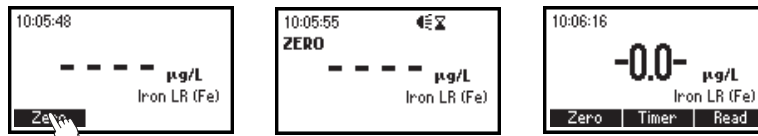

- Remove the cuvette.
- Fill another graduated mixing cylinder up to the 25 mL mark with the sample.
- Add the content of one packet of HI 93746-0 TPTZ reagent, close the cylinder and shake vigorously for 30 seconds. This is the reacted sample.

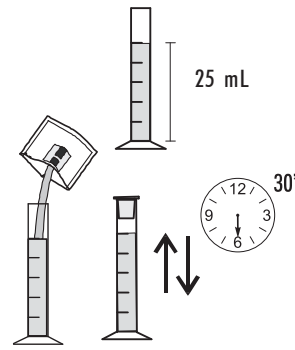

- Fill a cuvette with 10 mL of the reacted sample up to the mark and replace the cap.
- Insert the sample into the instrument.

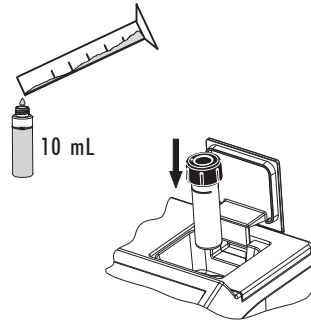

- Press **Timer** and the display will show the countdown prior to the measurement or, alternatively, wait for 30 seconds and press **Read**. When the timer ends the meter will perform the reading. The instrument displays concentration in  $\mu\text{g/L}$  of iron.

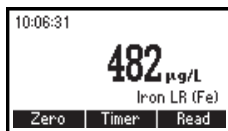

## **INTERFERENCES**

Interference may be caused by:

Cadmium above 4.0 mg/L

Chromium<sup>3+</sup> above 0.25 mg/L

Chromium<sup>6+</sup> above 1.2 mg/L

Cobalt above 0.05 mg/L

Copper above 0.6 mg/L

Cyanide above 2.8 mg/L

Manganese above 50.0 mg/L

Mercury above 0.4 mg/L

Molybdenum above 4.0 mg/L

Nickel above 1.0 mg/L

Nitrite ion above 0.8 mg/L

Sample pH should be between 3 and 4 to avoid developed color to fade or turbidity formation.

## MOLYBDENUM

### SPECIFICATIONS

<b>Range</b>	0.0 to 40.0 mg/L
<b>Resolution</b>	0.1 mg/L
<b>Accuracy</b>	±0.3 mg/L ±5% of reading at 25 °C
<b>Typical EMC Deviation</b>	±0.1 mg/L
<b>Light Source</b>	Tungsten lamp with narrow band interference filter @ 420 nm
<b>Method</b>	Adaptation of the mercaptoacetic acid method. The reaction between molybdenum and the reagents causes a yellow tint in the sample.

### REQUIRED REAGENT

<u>Code</u>	<u>Description</u>	<u>Quantity</u>
HI 93730A-0	Reagent A	1 packet
HI 93730B-0	Reagent B	1 packet
HI 93730C-0	Reagent C	1 packet

### REAGENT SETS

**HI 93730-01** Reagents for 100 tests

**HI 93730-03** Reagents for 300 tests

For other accessories see page 66.

### MEASUREMENT PROCEDURE

- Select the *Molybdenum* method using the procedure described in the *Method Selection* section (see page 12).
- Fill the cuvette with 10 mL of unreacted sample (up to the mark) and replace the cap.
 

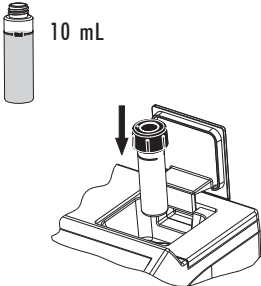
- Place cuvette into the holder and close the lid.
- Press the **Zero** key. The display will show “-0.0-” when the meter is zeroed and ready for measurement.

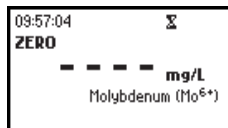
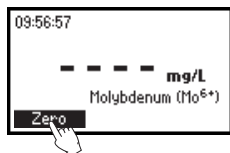



- Fill one graduated mixing cylinder up to the 25 mL mark with the sample.

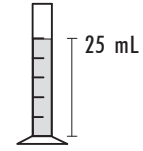

- Add the content of one packet of HI 93730A-0 molybdenum reagent, close the cylinder and invert it several times until completely dissolved.

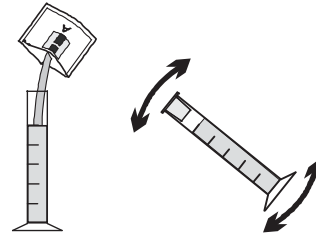

- Add the content of one packet of HI 93730B-0 molybdenum reagent to the cylinder, close and invert it several times until completely dissolved.

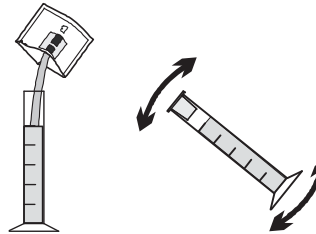

- Add the content of one packet of HI 93730C-0 molybdenum reagent to the cylinder, close and shake it vigorously.

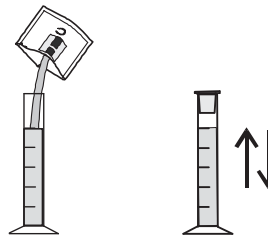

- Fill an empty cuvette with 10 mL of sample up to the mark and replace the cap.

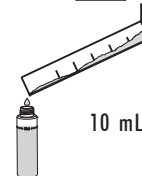

- Insert the cuvette into the instrument.

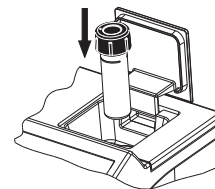

- Press **Timer** and the display will show the countdown prior to the measurement or, alternatively, wait for five minutes and press **Read**. When the timer ends the meter will perform the reading. The instrument displays concentration in **mg/L of molybdenum**.

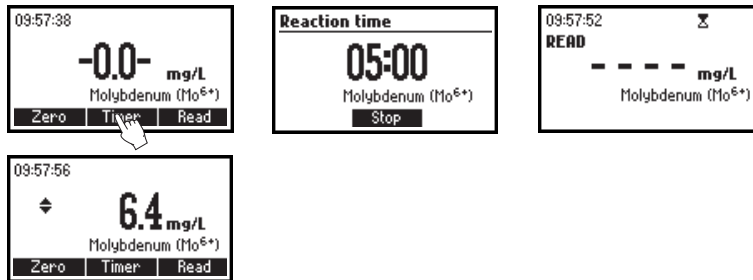

- Press ▲ or ▼ to access the second level functions.
- Press the **Chem Frm** key to convert the result in mg/L of molybdate ( $\text{MoO}_4^{2-}$ ) and sodium molybdate ( $\text{Na}_2\text{MoO}_4$ ).

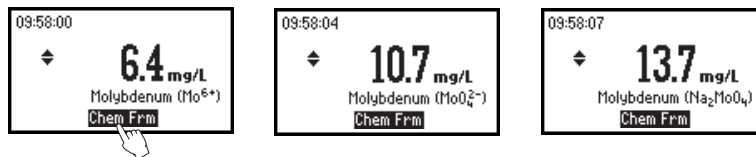

- Press ▲ or ▼ to return to the measurement screen.

### INTERFERENCES

Interference may be caused by:

Aluminum above 50 mg/L

Chromium above 1000 mg/L

Copper above 10 mg/L

Iron above 50 mg/L

Nickel above 50 mg/L

Nitrite, as  $\text{NO}_2^-$

Sulfate above 200 mg/L

Highly buffered samples or with extreme pH may exceed the buffering capacity of the reagents.

## NICKEL HIGH RANGE

### SPECIFICATIONS

<b>Range</b>	0.00 to 7.00 g/L
<b>Resolution</b>	0.01 g/L
<b>Accuracy</b>	$\pm 0.07 \pm 4\%$ of reading at 25 °C
<b>Typical EMC</b>	$\pm 0.02$ g/L
<b>Deviation</b>	
<b>Light Source</b>	Tungsten lamp with narrow band interference filter @ 575 nm
<b>Method</b>	Adaptation of the photometric method. The reaction between nickel and the reagent causes a blue tint in the sample.

### REQUIRED REAGENTS

<u>Code</u>	<u>Description</u>	<u>Quantity</u>
HI 93726-0	Powder reagent	1 packet

### REAGENT SETS

HI 93726-01 Reagents for 100 tests

HI 93726-03 Reagents for 300 tests

For other accessories see page 66.

### MEASUREMENT PROCEDURE

- Select the *Nickel HR* method using the procedure described in the *Method Selection* section (see page 12).

- Fill the cuvette up to the mark with 10 mL of unreacted sample and replace the cap.



- Place the cuvette into the holder and close the lid.

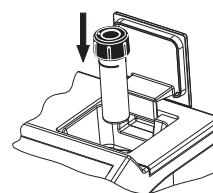

- Press the **Zero** key. The display will show “-0.0-” when the meter is zeroed and ready for measurement.

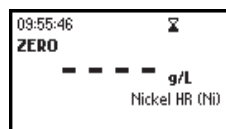
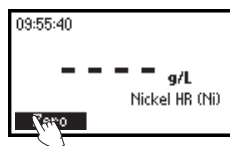

- Remove the cuvette and add the content of one packet of HI 93726-0 reagent. Replace the cap and shake gently until completely dissolved.

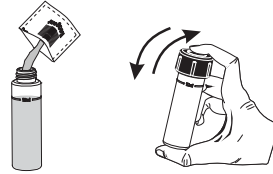

- Reinsert the cuvette into the instrument.

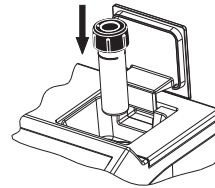

- Press **Timer** and the display will show the countdown prior to the measurement or, alternatively, wait for 1 minute and press **Read**. When the timer ends the meter will perform the reading.

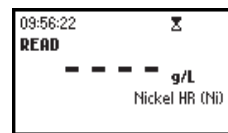

- The instrument displays concentration in g/L of nickel.

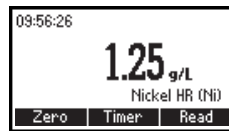

### INTERFERENCES

Interference may be caused by copper.

## NICKEL LOW RANGE

### SPECIFICATIONS

Range	0.000 to 1.000 mg/L
Resolution	0.001 mg/L
Accuracy	$\pm 0.010$ mg/L $\pm 7\%$ of reading at 25 °C
Typical EMC	$\pm 0.001$ mg/L
Deviation	
Light Source	Tungsten lamp with narrow band interference filter @ 575 nm
Method	Adaptation of the PAN method. The reaction between nickel and the reagents causes an orange tint in the sample.

### REQUIRED REAGENTS

Code	Description	Quantity
HI 93740A-0	Phthalate-phosphate	2 packets
HI 93740B-0	0.3% PAN indicator	2 mL
HI 93740C-0	EDTA	2 packets
HI 93703-51	Dispersing Agent	4-6 drops (only when necessary, see note)

### REAGENT SETS

HI 93740-01 Reagents for 50 tests

HI 93740-03 Reagents for 150 tests

For other accessories see page 66.

### MEASUREMENT PROCEDURE

- Select the *Nickel LR* method using the procedure described in the *Method Selection* section (see page 12).

**Note:** for best results perform your tests between 20-24°C.

- Fill one graduated beaker with 25 mL of deionized water (blank) and another one with 25 mL of sample.
- Add the content of one packet of HI 93740A-0 Phthalate-phosphate reagent to each beaker. Cap and swirl gently until the reagent is dissolved.

**Note:** If sample contains iron ( $\text{Fe}^{3+}$ ), it is important that all powder be dissolved completely before continuing with following step.

- Add 1 mL of HI 93740B-0 0.3% PAN solution to each beaker, cap and swirl to mix.

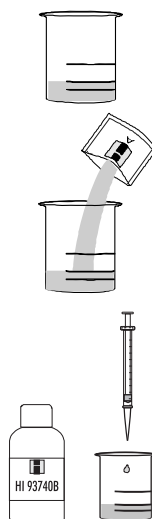

- Press **Timer** and the display will show a countdown prior to adding reagent C or, alternatively, wait for 15 minutes. Add one packet of HI 93740C-0 EDTA reagent to each beaker, cap and swirl to mix until completely dissolved.

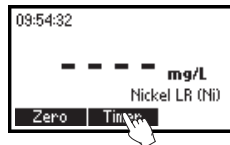

- Fill one cuvette up to the mark with 10 mL of the blank.



- Place the cuvette into the holder and close the lid.

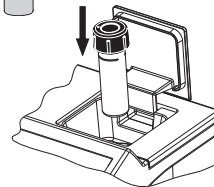

- Press the **Zero** key. The display will show “-0.0-” when the meter is zeroed and ready for measurement.

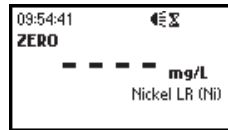
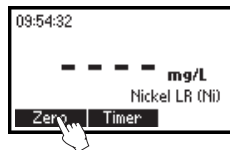

- Fill a second cuvette up to the mark with 10 mL of the reacted sample.



- Insert the second cuvette into the instrument.

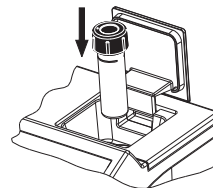

- Press **Read** to start the reading. The instrument displays the results in **mg/L of nickel**.

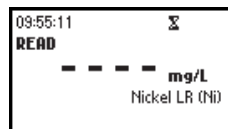

**Note:** a temperature above 30°C may cause turbidity. In this case, before zeroing and taking readings, add 2-3 drops of Dispersing Agent (HI 93703-51) to each cuvette and swirl until turbidity is removed.

### INTERFERENCES

Interference may be caused by:

- Co<sup>2+</sup> must not be present
- Fe<sup>2+</sup> must not be present
- Al<sup>3+</sup> above 32 mg/L
- Ca<sup>2+</sup> above 1000 mg/L (as CaCO<sub>3</sub>)
- Cd<sup>2+</sup> above 20 mg/L
- Cl<sup>-</sup> above 8000 mg/L
- Cr<sup>3+</sup> above 20 mg/L
- Cr<sup>6+</sup> above 40 mg/L
- Cu<sup>2+</sup> above 15 mg/L
- F<sup>-</sup> above 20 mg/L
- Fe<sup>3+</sup> above 10 mg/L
- K<sup>+</sup> above 500 mg/L
- Mg<sup>2+</sup> above 400 mg/L
- Mn<sup>2+</sup> above 25 mg/L
- Mo<sup>6+</sup> above 60 mg/L
- Na<sup>+</sup> above 5000 mg/L
- Pb<sup>2+</sup> above 20 mg/L
- Zn<sup>2+</sup> above 30 mg/L

## pH

### SPECIFICATIONS

Range	6.5 to 8.5 pH
Resolution	0.1 pH
Accuracy	$\pm 0.1$ pH at 25 °C
Typical EMC	$\pm 0.1$ pH
Deviation	
Light Source	Tungsten lamp with narrow band interference filter @ 525 nm
Method	Adaptation of the Phenol Red method. The reaction with the reagent causes a yellow to red tint in the sample.

### REQUIRED REAGENTS

Code	Description	Quantity
HI 93710-0	Phenol Red Indicator	5 drops

### REAGENT SETS

HI 93710-01 Reagents for 100 pH tests

HI 93710-03 Reagents for 300 pH tests

For other accessories see page 66.

### MEASUREMENT PROCEDURE

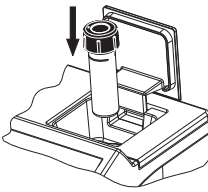
- Select the *pH* method using the procedure described in the *Method Selection* section (see page 12).
- Fill the cuvette with 10 mL of unreacted sample (up to the mark) and replace the cap.
- Place the cuvette into the holder and close the lid.
- Press the **Zero** key. The display will show “-0.0-” when the meter is zeroed and ready for measurement.

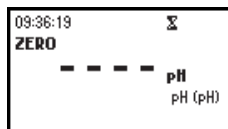
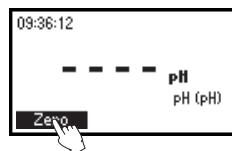



- Remove the cuvette and add 5 drops of HI 93710-0 Phenol Red Indicator. Replace the cap and mix the solution.

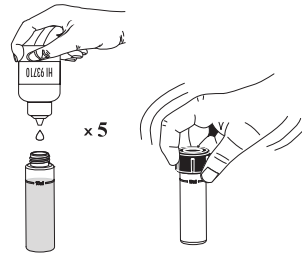

- Reinsert the cuvette into the instrument.

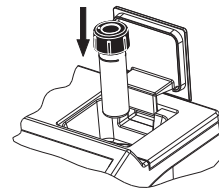

- Press the **Read** key to start the reading. The instrument displays the **pH value**.

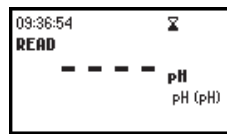
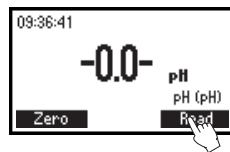

## PHOSPHATE HIGH RANGE

### SPECIFICATIONS

<b>Range</b>	0.0 to 30.0 mg/L
<b>Resolution</b>	0.1 mg/L
<b>Accuracy</b>	± 1 mg/L ± 4% of reading at 25 °C
<b>Typical EMC Dev.</b>	± 0.1 mg/L
<b>Light Source</b>	Tungsten lamp with narrow band interference filter @ 525 nm
<b>Method</b>	Adaptation of the <i>Standard Methods for the Examination of Water and Wastewater, 18<sup>th</sup> edition</i> , Amino Acid method. The reaction between phosphate and reagents causes a blue tint in the sample.

### REQUIRED REAGENTS

<u>Code</u>	<u>Description</u>	<u>Quantity</u>
HI 93717A-0	Molybdate	10 drops
HI 93717B-0	Reagent B	1 packet

### REAGENT SETS

HI 93717-01 Reagents for 100 tests

HI 93717-03 Reagents for 300 tests

For other accessories see page 66.

### MEASUREMENT PROCEDURE

- Select the *Phosphate HR* method using the procedure described in the *Method Selection* section (see page 12).
- Fill the cuvette with 10 mL of unreacted sample (up to the mark) and replace the cap.
- Place the cuvette into the holder and close the lid.
- Press the **Zero** key. The display will show “-0.0-” when the meter is zeroed and ready for measurement.

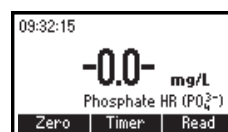
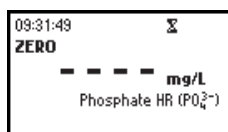
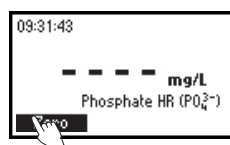
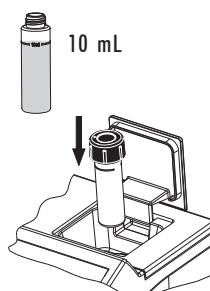

- Remove the cuvette.
- Add 10 drops of HI 93717A-0 Molybdate reagent.



- Add the content of one packet of HI 93717B-0 Phosphate HR Reagent B to the cuvette. Replace the cap and shake gently until completely dissolved.

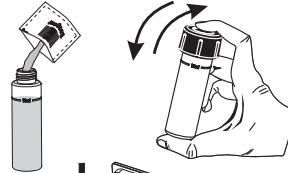

- Reinsert the cuvette into the instrument.

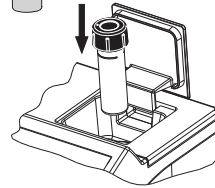

- Press **Timer** and the display will show the countdown prior to the measurement or, alternatively, wait for 5 minutes and press **Read**. When the timer ends the meter will perform the reading. The instrument displays the results in **mg/L of phosphate ( $\text{PO}_4^{3-}$ )**.

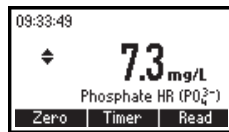
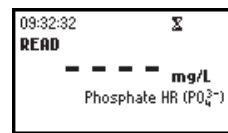
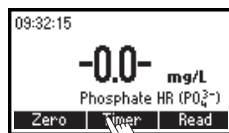

- Press **▲** or **▼** to access the second level functions.
- Press the **Chem Frm** key to convert the result in mg/L of phosphorus (P) and phosphorus pentoxide ( $\text{P}_2\text{O}_5$ ).

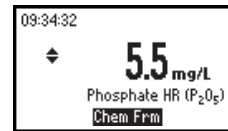
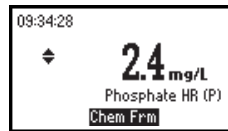
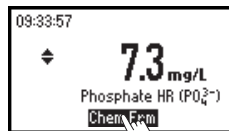

- Press **▲** or **▼** to return to the measurement screen.

## INTERFERENCES

Sulfide

Chloride above 150000 mg/L

Calcium above 10000 mg/L as  $\text{CaCO}_3$

Magnesium above 40000 mg/L as  $\text{CaCO}_3$

Ferrous iron above 100 mg/L

## PHOSPHATE LOW RANGE

### SPECIFICATIONS

<b>Range</b>	0.00 to 2.50 mg/L
<b>Resolution</b>	0.01 mg/L
<b>Accuracy</b>	±0.04 mg/L ±4% of reading at 25 °C
<b>Typical EMC Dev.</b>	±0.01 mg/L
<b>Light Source</b>	Tungsten lamp with narrow band interference filter @ 610 nm
<b>Method</b>	Adaptation of the Ascorbic Acid method. The reaction between phosphate and the reagent causes a blue tint in the sample.

### REQUIRED REAGENTS

<u>Code</u>	<u>Description</u>	<u>Quantity</u>
HI 93713-0	Powder reagent	1 packet

### REAGENT SETS

HI 93713-01 Reagents for 100 tests

HI 93713-03 Reagents for 300 tests

For other accessories see page 66.

### MEASUREMENT PROCEDURE

- Select the *Phosphate LR* method using the procedure described in the *Method Selection* section (see page 12).
- Rinse, cap and shake the cuvette several times with unreacted sample. Fill the cuvette with 10 mL of sample up to the mark and replace the cap.
- Place the cuvette into the holder and close the lid.
- Press the **Zero** key. The display will show “-0.0-” when the meter is zeroed and ready for measurement.

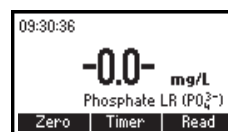
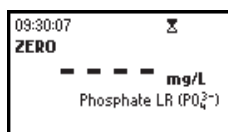
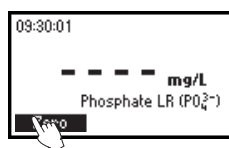
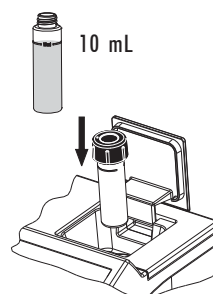

- Remove the cuvette and add the content of one packet of HI 93713-0 reagent. Replace the cap and shake gently (for about 2 minutes) until the powder is completely dissolved.

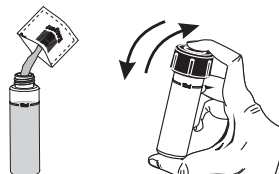

- Reinsert the cuvette into the instrument.

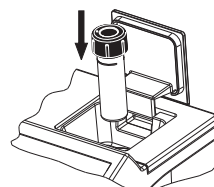

- Press **Timer** and the display will show the countdown prior to the measurement or, alternatively, wait for 3 minutes and press **Read**. When the timer ends the meter will perform the reading. The instrument displays concentration in **mg/L of phosphate ( $\text{PO}_4^{3-}$ )**.

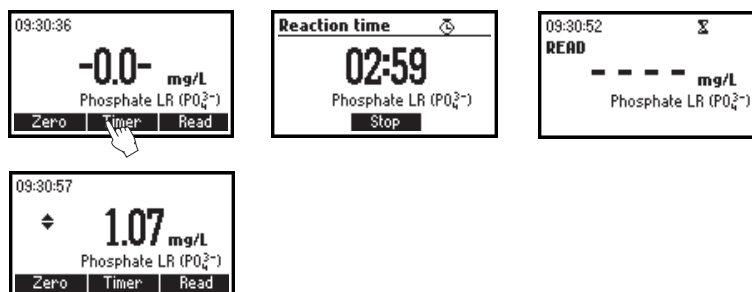

- Press **▲** or **▼** to access the second level functions.
- Press the **Chem Frm** key to convert the result in mg/L of phosphorus (P) and phosphorus pentoxide ( $\text{P}_2\text{O}_5$ ).

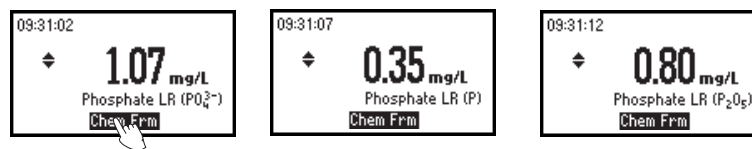

- Press **▲** or **▼** to return to the measurement screen.

### **INTERFERENCES**

Interference may be caused by:

Iron above 50 mg/L

Silica above 50 mg/L

Silicate above 10 mg/L

Copper above 10 mg/L

Hydrogen sulfide, arsenate, turbid sample and highly buffered samples also interfere.

# PHOSPHORUS

## SPECIFICATIONS

<b>Range</b>	0.0 to 15.0 mg/L
<b>Resolution</b>	0.1 mg/L
<b>Accuracy</b>	±0.3 mg/L ±4% of reading at 25 °C
<b>Typical EMC Dev.</b>	±0.2 mg/L
<b>Light Source</b>	Tungsten lamp with narrow band interference filter @ 525 nm
<b>Method</b>	Adaptation of the <i>Standard Methods for the Examination of Water and Wastewater, 18<sup>th</sup> edition</i> , Amino Acid method. The reaction between phosphate and reagents causes a blue tint in the sample.

## REQUIRED REAGENTS

<u>Code</u>	<u>Description</u>	<u>Quantity</u>
HI 93706A-0	Molybdate	10 drops
HI 93706B-0	Amino Acid Powder	1 packet

## REAGENT SETS

HI 93706-01 Reagents for 100 tests

HI 93706-03 Reagents for 300 tests

For other accessories see page 66.

## MEASUREMENT PROCEDURE

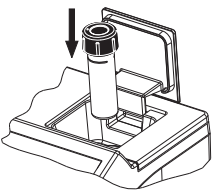
- Select the *Phosphorus* method using the procedure described in the *Method Selection* section (see page 12).
- Fill the cuvette with 10 mL of unreacted sample (up to the mark) and replace the cap. 
- Place the cuvette into the holder and close the lid. 
- Press the **Zero** key. The display will show “-0.0-” when the meter is zeroed and ready for measurement.

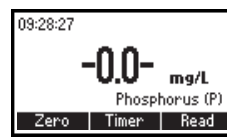
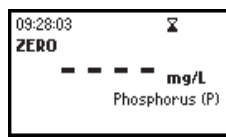
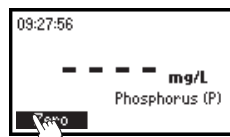

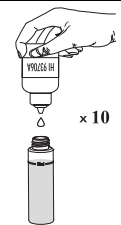
- Remove the cuvette.
- Add 10 drops of HI 93706A-0 Molybdate reagent. 

- Add the content of one packet of HI 93706B-0 Phosphorus Reagent B (Amino Acid) to the cuvette. Replace the cap and shake gently until completely dissolved.

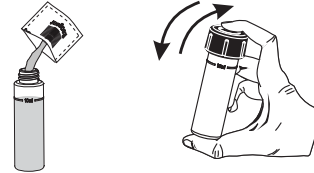

- Reinsert the cuvette into the instrument.

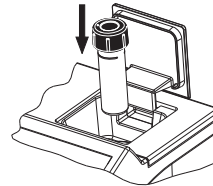

- Press **Timer** and the display will show the countdown prior to the measurement or, alternatively, wait for 5 minutes and press **Read**. When the timer ends the meter will perform the reading. The instrument displays the results in **mg/L of phosphorus (P)**.

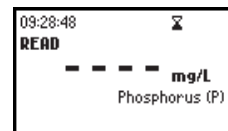
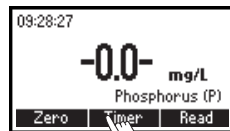

- Press **▲** or **▼** to access the second level functions.
- Press the **Chem Frm** key to convert the result in mg/L of phosphate ( $\text{PO}_4^{3-}$ ) and phosphorus pentoxide ( $\text{P}_2\text{O}_5$ ).

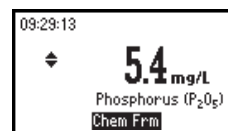
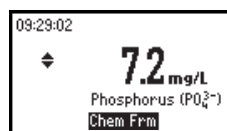
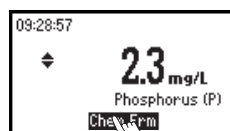

- Press **▲** or **▼** to return to the measurement screen.

### INTERFERENCES

Interference may be caused by:

Sulfide

Chloride above 150000 mg/L

Calcium above 10000 mg/L as  $\text{CaCO}_3$

Magnesium above 40000 mg/L as  $\text{CaCO}_3$

Ferrous iron above 100 mg/L

## SILICA

### SPECIFICATIONS

Range	0.00 to 2.00 mg/L
Resolution	0.01 mg/L
Accuracy	$\pm 0.03$ mg/L $\pm 3\%$ of reading at 25 °C
Typical EMC Deviation	$\pm 0.01$ mg/L
Light Source	Tungsten lamp with narrow band interference filter @ 610 nm
Method	Adaptation of the <i>ASTM Manual of Water and Environmental Technology, D859</i> , Heteropoly Blue method. The reaction between silica and reagents causes a blue tint in the sample.

### REQUIRED REAGENTS

Code	Description	Quantity
HI 93705A-0	Molybdate	6 drops
HI 93705B-0	Citric acid	1 packet
HI 93705C-0	Amino acid	1 packet

### REAGENT SETS

HI 93705-01 Reagents for 100 tests

HI 93705-03 Reagents for 300 tests

For other accessories see page 66.

### MEASUREMENT PROCEDURE

- Select the *Silica* method using the procedure described in the *Method Selection* section (see page 12).
- Fill the cuvette with 10 mL of unreacted sample (up to the mark).
- Add 6 drops of HI 93705A-0 Molybdate reagent. Replace the cap and swirl the solution.
- Wait for 4 minutes, add the content of one packet of HI 93705B-0 Citric acid reagent and shake until it is completely dissolved.
- Wait for 1 minute. This is the blank.
- Place the cuvette into the holder and close the lid.

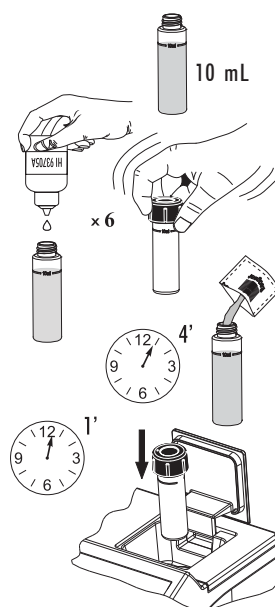



- Press the **Zero** key. The display will show “-0.0-” when the meter is zeroed and ready for measurement.

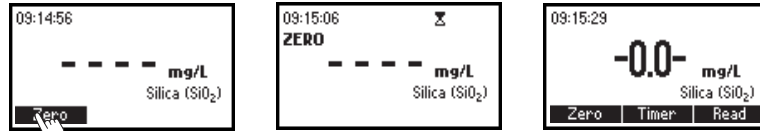

- Remove the cuvette and add the content of one packet of HI 93705C-0 Amino acid reagent and shake until it is completely dissolved.
- Reinsert the cuvette into the instrument.
- Press **Timer** and the display will show the countdown prior to the measurement. Alternatively, wait for exactly 3 minutes and press **Read**. When the timer ends the meter will perform the reading. The instrument displays concentration in **mg/L of silica (SiO<sub>2</sub>)**.

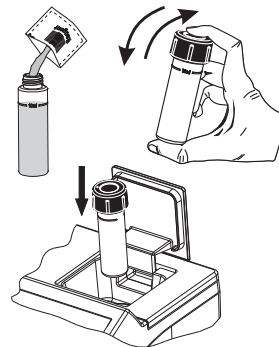

- Press **▲** or **▼** to access the second level functions.
- Press the **Chem Frm** key to convert the result in mg/L of Silicon (Si).

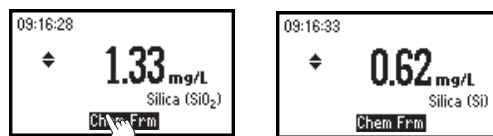

- Press **▲** or **▼** to return to the measurement screen.

### INTERFERENCES

Interference may be caused by:

Phosphate above 60 mg/L

Phosphate above 75 mg/L

Sulfide and high concentration of iron

Eliminate color and turbidity interferences by zeroing the meter with the original water sample.

## SILVER

### SPECIFICATIONS

Range	0.000 to 1.000 mg/L
Resolution	0.005 mg/L
Accuracy	$\pm 0.020$ mg/L $\pm 5\%$ of reading at 25 °C
Typical EMC	$\pm 0.001$ mg/L
Deviation	
Light Source	Tungsten lamp with narrow band interference filter @ 575 nm.
Method	Adaptation of the PAN method. The reaction between silver and reagents causes an orange tint in the sample.

### REQUIRED REAGENTS

Code	Description	Quantity
HI 93737A-0	Buffer Reagent A	1 mL
HI 93737B-0	Buffer Reagent B	1 mL
HI 93737C-0	Indicator Reagent C	2 mL
HI 93737D-0	Fixing Reagent D	2 mL
HI 93703-51	Dispersing Agent	4-6 drops

### REAGENT SETS

HI 93737-01 Reagents for 50 tests

HI 93737-03 Reagents for 150 tests

For other accessories see page 66.

### MEASUREMENT PROCEDURE

- Select the *Silver* method using the procedure described in the *Method Selection* section (see page 12).

**Note:** for best results perform your tests between 20-24°C.

- Fill two graduated beakers with 25 mL of sample.

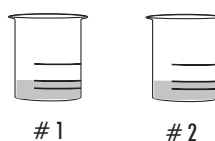

- Add 1.0 mL of HI 93737A-0 Buffer reagent to one beaker (the blank) and swirl gently to mix.

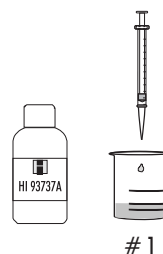

- Add exactly 1.0 mL of HI 93737B-0 Buffer reagent to the second beaker (the sample) and swirl gently to mix. Press **Timer** and the display will show the countdown prior to adding reagent C or, alternatively, wait for 2 minutes.

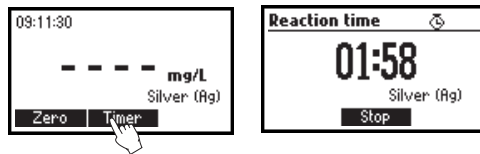

- Then add exactly 1.0 mL of HI 93737C-0 Indicator reagent to each beaker and swirl. Press **Timer** or, alternatively, wait for 2 minutes.

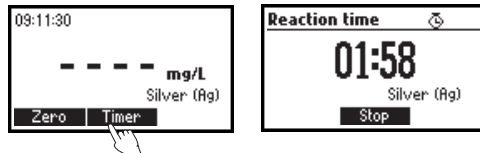

- Then, in both cases, add 1.0 mL of HI 93737D-0 Fixing reagent to each beaker and swirl. Press **Timer** or, alternatively, wait for 2 minutes.

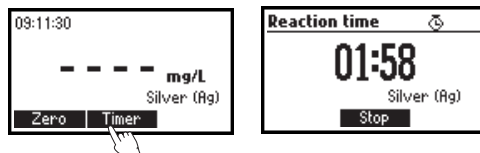

- Fill one cuvette up to the mark with 10 mL of the blank.
- Add 3 drops of Dispersing Agent (HI 93703-51), replace the cap and invert gently to mix for about 10 seconds.
- Place the cuvette into the holder and close the lid.

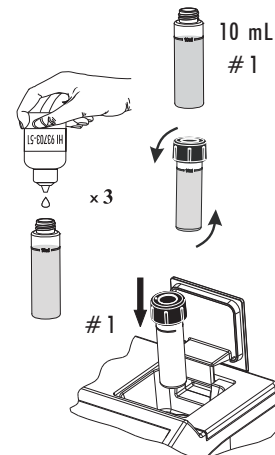
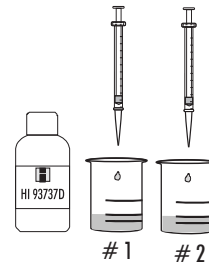
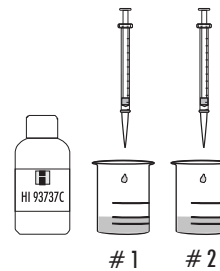
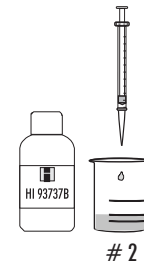

- Press the **Zero** key. The display will show “-0.0-” when the meter is zeroed and ready for measurement.

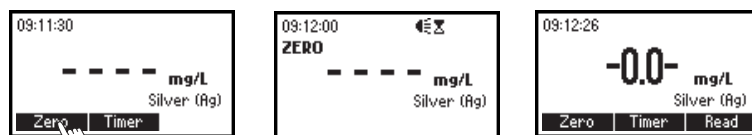

- Fill a second cuvette up to the mark with 10 mL of the reacted sample.



- Add 3 drops of Dispersing Agent (HI 93703-51), replace the cap and invert gently to mix for about 10 seconds.

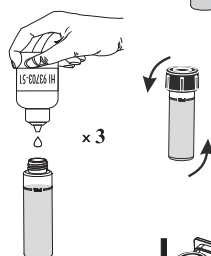

- Insert the second cuvette into the instrument.

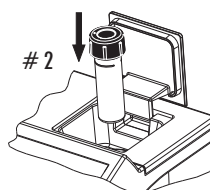

- Press **Read** to start the reading. The instrument displays the results in **mg/L of silver**.



## INTERFERENCES

Interference may be caused by:

Al <sup>3+</sup> above 30 mg/L	Fe <sup>2+</sup> above 1.5 mg/L
Ca <sup>2+</sup> above 1000 mg/L as CaCO <sub>3</sub>	Fe <sup>3+</sup> above 10 mg/L
Cd <sup>2+</sup> above 20 mg/L	K <sup>+</sup> above 500 mg/L
Cl <sup>-</sup> above 8000 mg/L	Mn <sup>2+</sup> above 25 mg/L
Co <sup>2+</sup> above 1.5 mg/L	Mg <sup>2+</sup> above 1000 mg/L as CaCO <sub>3</sub>
Cr <sup>3+</sup> above 20 mg/L	Na <sup>+</sup> above 5000 mg/L
Cr <sup>6+</sup> above 40 mg/L	Ni <sup>2+</sup> above 1.5 mg/L
Cu <sup>2+</sup> above 15 mg/L	Pb <sup>2+</sup> above 20 mg/L
F <sup>-</sup> above 20 mg/L	Zn <sup>2+</sup> above 30 mg/L

## ZINC

### SPECIFICATIONS

Range	0.00 to 3.00 mg/L
Resolution	0.01 mg/L
Accuracy	$\pm 0.03$ mg/L $\pm 3\%$ of reading at 25 °C
Typical EMC Deviation	$\pm 0.01$ mg/L
Light Source	Tungsten lamp with narrow band interference filter @ 575 nm
Method	Adaptation of the <i>Standard Methods for the Examination of Water and Wastewater, 18<sup>th</sup> edition</i> , Zincon method. The reaction between zinc and the reagents causes an orange to a dark violet tint in the sample.

### REQUIRED REAGENT

Code	Description	Quantity
HI 93731A-0	Zinc Reagent	1 packet
HI 93731B-0	Cyclohexanone	0.5 mL

### REAGENT SETS

HI 93731-01 Reagents for 100 tests

HI 93731-03 Reagents for 300 tests

For other accessories see page 66.

### MEASUREMENT PROCEDURE

- Select the *Zinc* method using the procedure described in the *Method Selection* section (see page 12).
- Fill one graduated mixing cylinder up to the 20 mL mark with the sample.
- Add the content of one packet of HI 93731A-0 Zinc reagent, close the cylinder and invert several times to mix until completely dissolved.
- Fill one cuvette with 10 mL of the reacted sample up to the mark.

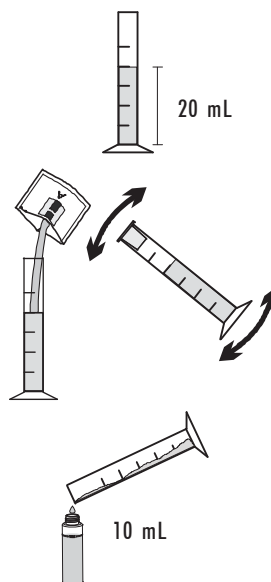

- Place the cap and insert the cuvette into the instrument and close the lid.
- Press the **Zero** key. The display will show “-0.0-” when the meter is zeroed and ready for measurement.

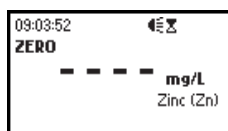
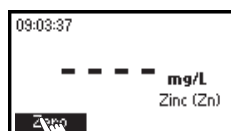
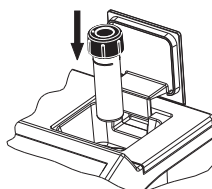

- Remove the cuvette and add 0.5 mL of HI 93731B-0 Cyclohexanone to the cuvette.

**Note:** To prevent any contamination from the polycarbonate cap, prior to replacing it, close the sample cuvette with the supplied HDPE plastic stopper.

- Replace the cap and mix the sample for 15 seconds.
- Insert the sample into the instrument.

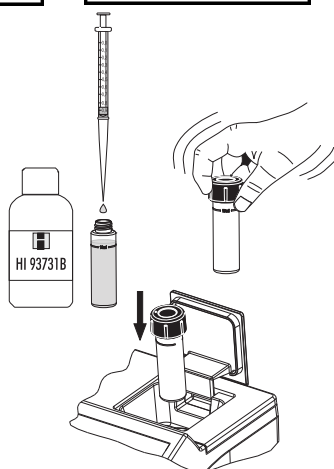

- Press **Timer** and the display will show the countdown prior to the measurement or, alternatively, wait for 3 minutes and 30 seconds and press **Read**. When the timer ends the meter will perform the reading.

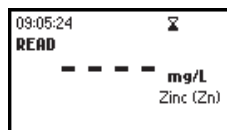

- The instrument displays the results in **mg/L** of zinc.



### INTERFERENCES

Interference may be caused by:

- Aluminum above 6 mg/L
- Cadmium above 0.5 mg/L
- Copper above 5 mg/L
- Iron above 7 mg/L
- Manganese above 5 mg/L
- Nickel above 5 mg/L

## ERRORS AND WARNINGS

The instrument shows clear warning messages when erroneous conditions appear and when measured values are outside the expected range. These messages are described below.



**No Light:** The light source is not functioning properly.



**Light Leak:** There is an excess amount of ambient light reaching the detector.



**Inverted cuvettes:** The sample and the zero cuvettes are inverted.



**Battery Low:** The battery capacity is lower than 10%.



**Light Low:** The instrument cannot adjust the light level. Please check that the sample does not contain any debris.



**Light High:** There is too much light to perform a measurement. Please check the preparation of the zero cuvette.

## DATA MANAGEMENT

The analyzed data can be managed using Hanna's product HI92000, Windows® Compatible Software.

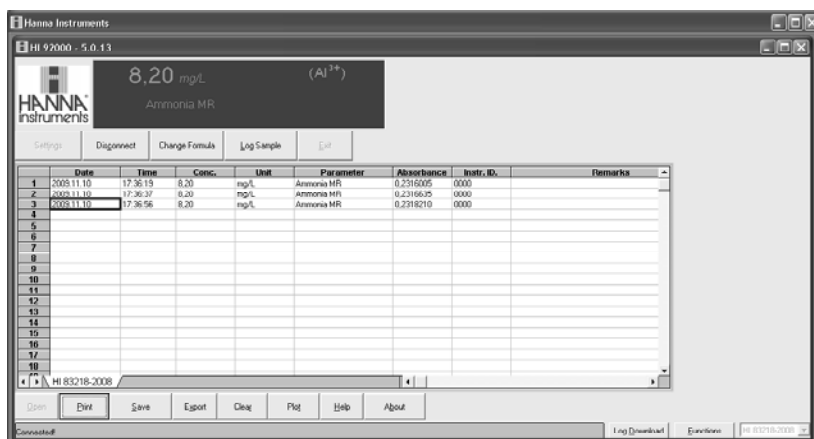

Windows® is registered Trademark of "Microsoft Co."



## STANDARD METHODS

<u>Description</u>	<u>Range</u>	<u>Method</u>
Ammonia MR	0.00 to 10.00 mg/L	Nessler
Ammonia LR	0.00 to 3.00 mg/L	Nessler
Chromium VI HR	0 to 1000 µg/L	Diphenylcarbohydrazide
Chromium VI LR	0 to 300 µg/L	Diphenylcarbohydrazide
Copper HR	0.00 to 5.00 mg/L	Bicinchoninate
Copper LR	0 to 1000 µg/L	Bicinchoninate
Cyanuric Acid	0 to 80 mg/L	Turbidimetric
Iodine	0.0 to 12.5 mg/L	DPD
Iron HR	0.00 to 5.00 mg/L	Phenantroline
Iron LR	0 to 400 µg/L	TPTZ
Molybdenum	0.0 to 40.0 mg/L	Mercaptoacetic Acid
Nickel HR	0.00 to 7.00 g/L	Photometric
Nickel LR	0.000 to 1.000 mg/L	PAN
pH	6.5 to 8.5 pH	Phenol Red
Phosphate HR	0.0 to 30.0 mg/L	Amino Acid
Phosphate LR	0.00 to 2.50 mg/L	Ascorbic Acid
Phosphorus	0.0 to 15.0 mg/L	Amino Acid
Silica	0.00 to 2.00 mg/L	Heteropoly Blue
Silver	0.000 to 1.000 mg/L	PAN
Zinc	0.00 to 3.00 mg/L	Zincon

## ACCESSORIES

### REAGENT SETS

HI 93700-01	100 ammonia LR tests
HI 93700-03	300 ammonia LR tests
HI 93702-01	100 copper HR tests
HI 93702-03	300 copper HR tests
HI 93705-01	100 silica tests
HI 93705-03	300 silica tests
HI 93706-01	100 phosphorus tests
HI 93706-03	300 phosphorus tests
HI 93710-01	100 pH tests
HI 93710-03	300 pH tests
HI 93712-01	100 aluminum tests
HI 93712-03	300 aluminum tests
HI 93713-01	100 phosphate LR tests
HI 93713-03	300 phosphate LR tests
HI 93715-01	100 ammonia MR tests
HI 93715-03	300 ammonia MR tests
HI 93717-01	100 phosphate HR tests
HI 93717-03	300 phosphate HR tests
HI 93718-01	100 iodine tests
HI 93718-03	300 iodine tests
HI 93721-01	100 iron HR tests
HI 93721-03	300 iron HR tests
HI 93722-01	100 cyanuric acid tests
HI 93722-03	300 cyanuric acid tests
HI 93723-01	100 chromium VI HR tests
HI 93723-03	300 chromium VI HR tests
HI 93726-01	100 nickel HR tests
HI 93726-03	300 nickel HR tests
HI 93730-01	100 molybdenum tests
HI 93730-03	300 molybdenum tests
HI 93731-01	100 zinc tests
HI 93731-03	300 zinc tests
HI 93737-01	50 silver tests
HI 93737-03	150 silver tests
HI 93740-01	50 nickel LR tests
HI 93740-03	150 nickel LR tests
HI 93746-01	50 iron LR tests
HI 93746-03	150 iron LR tests
HI 93749-01	100 chromium VI LR tests
HI 93749-03	300 chromium VI LR tests
HI 95747-01	100 copper LR tests
HI 95747-03	300 copper LR tests

### OTHER ACCESSORIES

HI 731318	cloth for wiping cuvettes (4 pcs)
HI 731321	glass cuvettes (4 pcs)
HI 731325W	new cap for cuvette (4 pcs)
HI 740034	cap for 100 mL beaker (6 pcs)
HI 740036	100 mL plastic beaker (6 pcs)
HI 740038	60 mL glass bottle and stopper
HI 740142	1 mL graduated syringe
HI 740143	1 mL graduated syringe (6 pcs)
HI 740144	pipette tip (6 pcs)
HI 740157	plastic refilling pipette (20 pcs)
HI 740220	25 mL glass cylinders with caps (2 pcs)
HI 740223	170 mL plastic beaker
HI 740224	170 mL plastic beakers (12 pcs)
HI 740225	60 mL graduated syringe
HI 740226	5 mL graduated syringe
HI 740227	filter assembly
HI 740228	filter discs (25 pcs)
HI 740229	100 mL graduated cylinder
HI 740230	230 mL demineralized water
HI 92000	Windows compatible software
HI 920013	PC connection cable
HI 93703-50	cuvette cleaning solution (230 mL)
HI 93703-54	dried resin (100 g)
HI 93703-55	activated carbon (50 pcs)

## WARRANTY

All Hanna Instruments meters are warranted for two years against defects in workmanship and materials when used for its intended purpose and maintained according to the instructions.

This warranty is limited to repair or replacement free of charge.

Damages due to accident, misuse, tampering or lack of prescribed maintenance are not covered.

If service is required, contact your dealer. If under warranty, report the model number, date of purchase, serial number and the nature of the failure. If the repair is not covered by the warranty, you will be notified of the charges incurred.

If the instrument is to be returned to Hanna Instruments, first obtain a Returned Goods Authorization Number from the Customer Service Department and then send it with shipment costs prepaid. When shipping any instrument, make sure it is properly packaged for complete protection.

To validate your warranty, fill out and return the enclosed warranty card within 14 days from the date of purchase.

### Recommendations for Users

Before using these products, make sure that they are entirely suitable for your specific application and for the environment in which they are used.

Operation of these instruments may cause unacceptable interferences to other electronic equipments, this requiring the operator to take all necessary steps to correct interferences.

Any variation introduced by the user to the supplied equipment may degrade the instruments' EMC performance.

To avoid damages or burns, do not put the instrument in microwave ovens. For yours and the instrument safety do not use or store the instrument in hazardous environments.

Hanna Instruments reserves the right to modify the design, construction and appearance of its products without advance notice.

## HANNA LITERATURE

Hanna publishes a wide range of catalogs and handbooks for an equally wide range of applications. The reference literature currently covers areas such as:

- **Water Treatment**
- **Process**
- **Swimming Pools**
- **Agriculture**
- **Food**
- **Laboratory**

and many others. New reference material is constantly being added to the library.

For these and other catalogs, handbooks and leaflets contact your dealer or the Hanna Customer Service Center nearest to you. To find the Hanna Office in your vicinity, check our home page at [www.hannainst.com](http://www.hannainst.com).