



PEWA
Messtechnik GmbH
Weidenweg 21
58239 Schwerte
Tel.: 02304-96109-0
Fax: 02304-96109-88
E-Mail: info@pewa.de
Homepage : www.pewa .de

Instruction Manual

pH 209 • pH 209R

Bench Top pH Meters

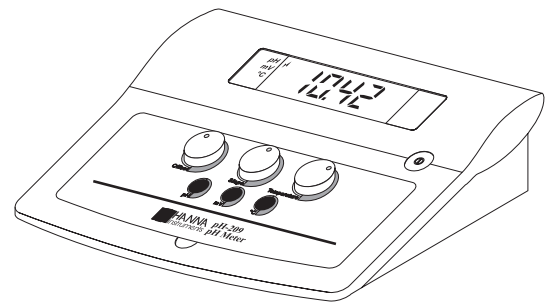



HANNA[®]
instruments
www.hannainst.com

Dear Customer,

Thank you for choosing a Hanna Instruments Product.

Please read this instruction manual carefully before using the instrument.

This manual will provide you with all the necessary information for the correct use of the instrument, as well as a precise idea of its versatility in a wide range of applications.

If you need additional technical information, do not hesitate to e-mail us at tech@hannainst.com.

These instruments are in compliance with the **CE** directives.

TABLE OF CONTENTS

PRELIMINARY EXAMINATION	3
GENERAL DESCRIPTION	3
FUNCTIONAL DESCRIPTION	4
SPECIFICATIONS	5
OPERATIONAL GUIDE	6
PH CALIBRATION	8
PH VALUES AT VARIOUS TEMPERATURES	10
ELECTRODE CONDITIONING & MAINTENANCE	11
TEMPERATURE-RESISTANCE CORRELATION FOR HANNA pH SENSITIVE GLASS	14
ACCESSORIES	15
ELECTRODE APPLICATION REFERENCE GUIDE	21
WARRANTY	22
CE DECLARATION OF CONFORMITY	23

PRELIMINARY EXAMINATION

Remove the instrument from the packing material and examine it carefully to make sure that no damage has occurred during shipping. If there is any damage, notify your dealer.

Each meter is supplied complete with:

- **HI 1332B** plastic-body combination double-junction refillable pH electrode with BNC connector and 1m (3.3') cable
- 12 Vdc adapter
- Instruction manual.

Note: Save all packing material until you are sure that the instrument functions correctly. All defective items must be returned in the original packing with the supplied accessories.

GENERAL DESCRIPTION

pH 209 bench-top pH meter is designed for simplicity of use.

It features a large easy-to-read liquid crystal display (LCD) and user friendly keyboard.

The pH calibration is made simple through the easy-to-operate front panel knobs for offset and slope adjustment.

A front knob is provided for easy manual temperature compensation of the pH reading.

pH 209 can also measure ion concentration (ISE) and ORP (Oxidation Reduction Potential) in the mV range.

The range selection (pH, mV or °C for temperature compensation) is made simple through the front membrane keyboard.

The large LCD is provided with arrows that quickly and clearly indicate the selected range.

It is also available the model **pH209R** with recorder output feature.

FUNCTIONAL DESCRIPTION

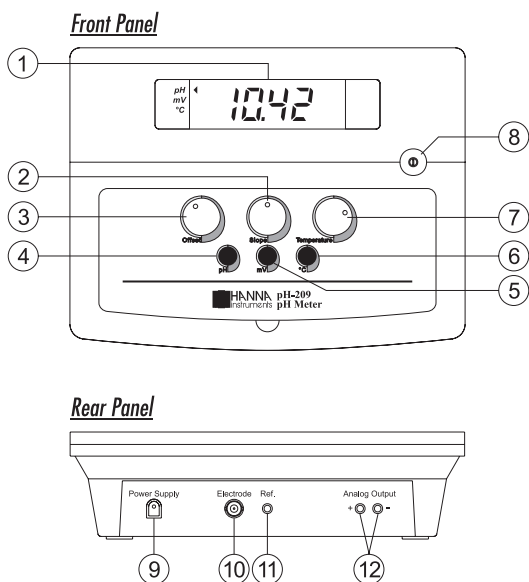

- 1) Liquid Crystal Display (LCD)
- 2) pH slope adjustment knob
- 3) pH offset adjustment knob
- 4) pH range selection key
- 5) mV range selection key
- 6) °C range selection key
- 7) Temperature setting knob
- 8) ON/OFF switch
- 9) Power adapter socket
- 10) BNC electrode connector
- 11) Electrode reference socket
- 12) Analog output (PH209R only)

SPECIFICATIONS

Range	0.00 to 14.00 pH ±1999 mV
Resolution	0.01 pH / 1 mV
Accuracy (@20°C)	±0.01 pH / ±1 mV
Typical EMC Deviation	±0.03 pH / ±2 mV
pH Calibration	Manual, 2 point, through knobs
Temperature Compensation	Manual from 0 to 100°C (32 to 212°F)
pH Electrode (included)	HI 1332B plastic body, double junction, refillable, with BNC and 1m (3.3') cable
Analog output (pH209R only)	0 to 5V 0 to 14 pH / -1999 to +1999 mV Temperature: always 0
Input Impedance	10 ¹² ohm
Power Supply	12 Vdc adapter (included)
Environment	0 to 50°C (32 to 122°F); RH max 95% non-condensing
Dimensions	240 x 182 x 74 mm (9.4x7.2x2.9")
Weight	approx. 1.0 kg (2.2 lb.)

OPERATIONAL GUIDE

Power connection

Plug the supplied 12 Vdc adapter into the power supply socket (#9 on page 4).

Note: Make sure the mains line is protected by a fuse.

Electrode connection

For combination pH or ORP electrodes (with internal reference) connect the electrode's BNC to the socket provided (#10 on page 4).



For an electrode with a separate reference, connect the measuring electrode's BNC to the BNC socket (#10 on page 4) and the reference electrode's jack to the socket provided (#11 on page 4).

Note: to prevent damage to the electrode, remove the pH electrode from the solution before turning the meter off.

If the meter is OFF, detach the electrode from the meter before immersing the electrode in the storage solution.

TAKING pH MEASUREMENTS

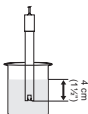
Make sure that the instrument has been calibrated for pH before taking pH measurements.

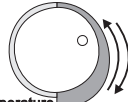
- Switch the instrument on by pressing the ON/OFF switch. 
- Immerse the electrode tip (4 cm / 1½") into the sample and shake briefly. 
- Take the temperature of the solution with a ChecktempC or a glass thermometer (e.g. 25°C). 
- Press the °C key to display temperature setting on the LCD and adjust the temperature knob to display the temperature of the sample.  

6

- Press the pH key to display the pH measurement. 

- The display shows the pH value of the test solution compensated for temperature.



If measurements are taken in different samples successively, it is recommended that the electrode be rinsed thoroughly for better conditioning and to eliminate cross-contamination of the sample.

For the rinsing process, it is recommended to use a liberal amount of the next solution to be measured.

TAKING ORP MEASUREMENTS

pH 209 has the capability to take ORP measurements, using an ORP electrode. Hanna Instruments offers a variety of ORP electrodes for this purpose (see accessories). Contact your Dealer for more information.

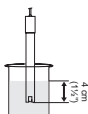
- Connect the ORP electrode to the meter and submerge the tip (4 cm / 1½") into the sample to be tested. 

Note: ORP measurements are taken without temperature compensation.

- Press the mV key to enter the mV mode. Allow a few minutes for the reading to stabilize. 
- The display will indicate the mV value (positive or negative).



AFTER MEASUREMENTS

- Press the ON/OFF switch again to switch the instrument off.

7

pH CALIBRATION

IMPORTANT

The instrument's pH range should be re-calibrated:

- When the meter is new.
- Whenever the pH electrode is replaced.
- At least once a month.
- After use in aggressive chemicals.
- After cleaning procedure and changing the reference electrolyte.
- For greatest accuracy.

INITIAL PREPARATION

Pour small quantities (up to 4cm / 1½" level) of pH 7.01 (HI 7007) and pH 4.01 (HI 7004) or pH 10.01 (HI 7010) solution into clean beakers. If possible use plastic beakers to minimize any EMC interferences.



If you are measuring in the acid range, use pH 4.01 as second buffer; if you are measuring in the alkaline range, use pH 10.01 as second buffer.

For accurate calibration, use two beakers for each buffer solution; the first for rinsing the electrode, the second for calibration. In this way, contamination of the buffer is minimized.



Note: The electrode should be submerged approximately 4 cm (1½") into the solution.

Note: If you need to calibrate to NBS standards, use pH 6.86 (HI 7006) and pH 9.18 (HI 7009) instead of pH 7.01 and 10.01 respectively.

Use a *ChecktempC* or a glass thermometer as reference.

PROCEDURE

- Switch the instrument on by pressing the ON/OFF button.
- Rinse and immerse the pH electrode into pH 7.01 buffer and shake briefly. Wait for the reading to stabilize.

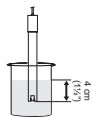

- Note the temperature of the buffer solution using a *ChecktempC* or a glass thermometer (e.g. 20°C).



- Press the °C key to select temperature setting.



- Adjust the Temperature knob until the LCD shows the noted temperature.

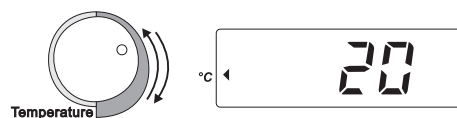

- Press the pH key to select pH measurement.



- Wait a couple of minutes and adjust the OFFSET knob until display shows the pH value at the noted temperature (see the pH versus temperature chart).

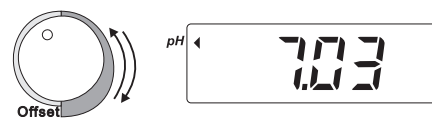

- Rinse and immerse the pH electrode in pH 4.01/pH 10.01 buffer and shake briefly.
- Wait a couple of minutes and adjust the SLOPE knob until display shows the pH value at the noted temperature (see the pH versus temperature chart).

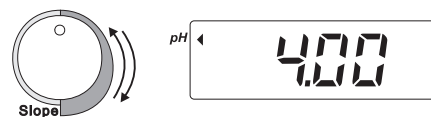

- The pH calibration is now complete.

pH VALUES AT VARIOUS TEMPERATURES

Temperature has an effect on pH. The calibration buffer solutions are affected by temperature changes to a lesser degree than normal solutions.

For manual temperature calibration please refer to the following chart.

TEMP		pH VALUES				
°C	°F	4.01	6.86	7.01	9.18	10.01
0	32	4.01	6.98	7.13	9.46	10.32
5	41	4.00	6.95	7.10	9.39	10.24
10	50	4.00	6.92	7.07	9.33	10.18
15	59	4.00	6.90	7.04	9.27	10.12
20	68	4.00	6.88	7.03	9.22	10.06
25	77	4.01	6.86	7.01	9.18	10.01
30	86	4.02	6.85	7.00	9.14	9.96
35	95	4.03	6.84	6.99	9.10	9.92
40	104	4.04	6.84	6.98	9.07	9.88
45	113	4.05	6.83	6.98	9.04	9.85
50	122	4.06	6.83	6.98	9.01	9.82
55	131	4.07	6.84	6.98	8.99	9.79
60	140	4.09	6.84	6.98	8.97	9.77
65	149	4.11	6.85	6.99	8.95	9.76
70	158	4.12	6.85	6.99	8.93	9.75

For instance, if the buffer temperature is 25°C, the display should show pH 4.01, 7.01 or 10.01 at pH 4, 7 or 10 buffers, respectively.

At 20°C, the display should show pH 4.00, 7.03 or 10.06. The meter reading at 50°C will then be 4.06, 6.98 or 9.82.

ELECTRODE CONDITIONING AND MAINTENANCE

Note: to prevent damage to the electrode, remove the pH electrode from the solution before turning the meter off.

If the meter is OFF, detach the electrode from the meter before immersing the electrode in the storage solution.

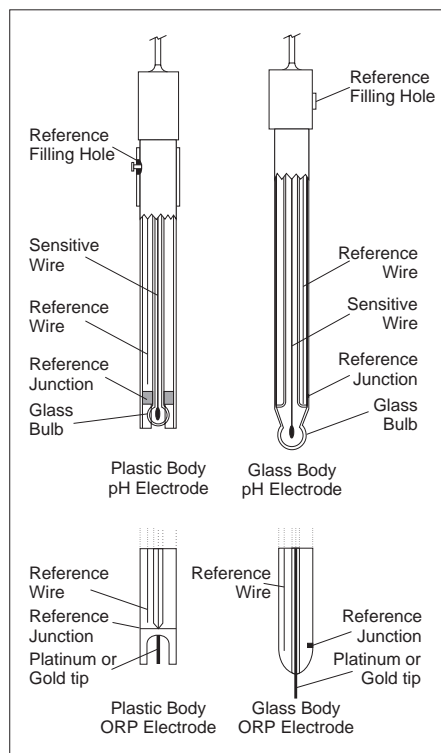

PREPARATION

Remove the protective cap.

DO NOT BE ALARMED IF SALT DEPOSITS ARE PRESENT. This is normal with electrodes and they will disappear when rinsed with water.

During transport tiny bubbles of air may form inside the glass bulb affecting proper functioning of the electrode. These bubbles can be removed by "shaking down" the electrode as you would do with a glass thermometer.

If the bulb and/or junction is dry, soak the electrode in HI 70300 storage solution for at least one hour.

For refillable electrodes:

If the filling solution (electrolyte) is more than 2½ cm (1") below the fill hole, add **HI 7082** 3.5M KCl electrolyte solution for double junction or **HI 7071** 3.5M KCl+AgCl electrolyte solution for single junction electrodes.

For a faster response, unscrew the fill hole screw during measurements.



For AmpHel® electrodes:

If the electrode does not respond to pH changes, the battery is run down and the electrode should be replaced.

MEASUREMENT

Rinse the electrode tip with distilled water. Immerse the tip (bottom 4 cm /1½") in the sample and stir gently for a few seconds.

For a faster response and to avoid cross contamination of the samples, rinse the electrode tip with a few drops of the solution to be tested, before taking measurements.

STORAGE

To minimize clogging and assure a quick response time, the glass bulb and the junction should be kept moist and not allowed to dry out.

Replace the protective cap with a few drops of **HI 70300** storage solution or, in its absence, electrolyte solution (**HI 7071** for single junction, or **HI 7082** for double junction electrodes). Follow the Preparation Procedure above before taking measurements.

NEVER STORE THE ELECTRODE IN DISTILLED OR DEIONIZED WATER.

PERIODIC MAINTENANCE

Inspect electrode and cable. The cable used for connection to the meter must be intact and there must be no points of broken insulation on the cable or cracks on the electrode stem or bulb. Connectors must be perfectly clean and dry. If any scratches or cracks are present, replace the electrode. Rinse off any salt deposits.

For refillable electrodes:

Refill the reference chamber with fresh electrolyte (**HI 7071** for single junction or **HI 7082** for double junction electrodes). Allow the electrode to stand upright for 1 hour.

Follow the Storage Procedure above.

CLEANING PROCEDURE

General Soak in **HI 7061** general cleaning solution for approximately 30 minutes.

Removal of films, dirt or deposits on the membrane/junction:

- *Protein* Soak in **HI 7073** protein cleaning solution for 15 min.

- *Inorganic* Soak in **HI 7074** inorganic cleaning solution for 15 minutes.

- *Oil/grease* Rinse with **HI 7077** Oil & Fat cleaning solution.

IMPORTANT: After performing any of the cleaning procedures rinse the electrode thoroughly with distilled water, refill the reference chamber with fresh electrolyte (not necessary for gel-filled electrodes) and soak the electrode in **HI 70300** storage solution for at least 1 hour before taking measurements.

TROUBLESHOOTING

Evaluate your electrode performance based on the following.

- **Noise** (Readings fluctuate up and down) could be due to:
 - **Clogged/Dirty Junction:** Refer to the Cleaning Procedure above.
 - **Loss of shielding** due to low electrolyte level (in refillable electrodes only): refill with fresh **HI 7071** for single junction or **HI 7082** for double junction electrodes.
- **Dry Membrane/Junction:** soak in **HI 70300** storage solution for at least 1 hour.
- **Drifting:** soak the electrode tip in warm (approx. 50-60°C) Hanna **HI 7082** solution for one hour and rinse the tip with distilled water. Refill with fresh **HI 7071** for single junction electrodes and **HI 7082** for double junction electrodes (refillable electrodes only).
- **Low Slope:** refer to the cleaning procedure above.
- **No Slope:** check the electrode for cracks in glass stem or bulb and replace the electrode.
- **Slow Response/Excessive Drift:** soak the tip in **HI 7061** solution for 30 minutes, rinse thoroughly in distilled water and then follow the Cleaning Procedure above.

TEMPERATURE-RESISTANCE CORRELATION FOR HANNA pH SENSITIVE GLASS

The resistance of glass electrodes partially depends on the temperature. The lower the temperature, the higher the resistance. It takes longer time for the reading to stabilize if the resistance is higher. In addition, the response time will suffer to a greater degree at temperatures below 10°C.

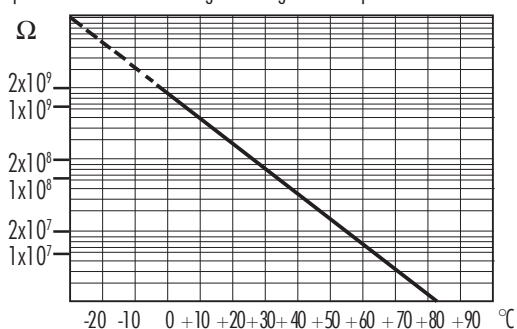

Since the resistance of the pH electrode is in the range of 200 Mohm, the current across the membrane is in the pico Ampere range. Large currents can disturb the calibration of the electrode for many hours.

For these reasons **high humidity environments, short circuits and static discharges** are detrimental to a stable pH reading.

The pH electrode's life also depends on the temperature. If constantly used at high temperatures, the electrode life is drastically reduced.

Typical Electrode Life

Ambient Temperature	1- 3 years
90 °C	Less than 4 months
120°C	Less than 1 month

High concentrations of sodium ions interfere with readings in alkaline solutions; the pH at which the interference starts to be significant depends upon the composition of the glass. This interference is the alkaline error and causes the pH to be underestimated. Hanna's glass formulations have the indicated characteristics.

Alkaline Error

Sodium Ion Correction for the Glass at 20-25°C		
Concentration	pH	Error
0.1 Mol L ⁻¹ Na ⁺	13.00	0.10
	13.50	0.14
	14.00	0.20
1.0 Mol L ⁻¹ Na ⁺	12.50	0.10
	13.00	0.18
	13.50	0.29
	14.00	0.40

ACCESSORIES

pH CALIBRATION SOLUTIONS

- HI 70004P pH 4.01 buffer solution, 20 mL sachet, 25 pcs
- HI 70007P pH 7.01 buffer solution, 20 mL sachet, 25 pcs
- HI 70010P pH 10.01 buffer solution, 20 mL sachet, 25 pcs
- HI 7004L pH 4.01 buffer solution, 500 mL
- HI 7006L pH 6.86 buffer solution, 500 mL
- HI 7007L pH 7.01 buffer solution, 500 mL
- HI 7009L pH 9.18 buffer solution, 500 mL
- HI 7010L pH 10.01 buffer solution, 500 mL
- HI 8004L pH 4.01 buffer solution in FDA bottle, 500 mL
- HI 8006L pH 6.86 buffer solution in FDA bottle, 500 mL
- HI 8007L pH 7.01 buffer solution in FDA bottle, 500 mL
- HI 8009L pH 9.18 buffer solution in FDA bottle, 500 mL
- HI 8010L pH 10.01 buffer solution in FDA bottle, 500 mL

ELECTRODE STORAGE SOLUTION

- HI 70300L Storage solution, 500 mL
- HI 80300L Storage solution in FDA bottle, 500 mL

ELECTRODE CLEANING SOLUTIONS

- HI 70000P Electrode rinsing solution, 20 mL sachet, 25 pcs
- HI 7061L General cleaning solution, 500 mL
- HI 7073L Protein cleaning solution, 500 mL
- HI 7074L Inorganic cleaning solution, 500 mL
- HI 7077L Oil & Fat cleaning solution, 500 mL
- HI 8061L General cleaning solution in FDA bottle, 500 mL
- HI 8073L Protein cleaning solution in FDA bottle, 500 mL
- HI 8077L Oil & Fat Cleaning solution in FDA bottle, 500 mL

ELECTROLYTE SOLUTIONS

- HI 7071 3.5M KCl + AgCl electrolyte solution, 4 x 30 mL, for single junction electrodes
- HI 7072 1M KNO₃ electrolyte solution, 4 x 30 mL
- HI 7082 3.5M KCl electrolyte solution, 4 x 30 mL, for double junction electrodes
- HI 8071 3.5M KCl + AgCl electrolyte solution in FDA bottle, 4 x 30 mL, for single junction electrodes
- HI 8072 1M KNO₃ electrolyte solution in FDA bottle, 4 x 30 mL
- HI 8082 3.5M KCl electrolyte solution in FDA bottle, 4 x 30 mL, for double junction electrodes

ORP PRETREATMENT SOLUTIONS

HI 7091L Reducing pretreatment solution, 500 mL

HI 7092L Oxidizing pretreatment solution, 500 mL

pH ELECTRODES

All electrodes part numbers ending in B are supplied with a BNC connector and 1 m (3.3') cable.

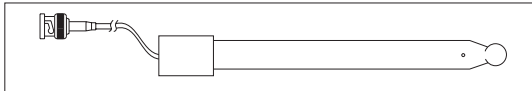

HI 1043B

Glass body, double junction, refillable, combination pH electrode. Use: strong acid/alkali.

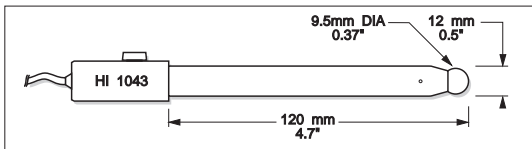

HI 1053B

Glass body, triple ceramic, conic shape, refillable, combination pH electrode. Use: emulsions.

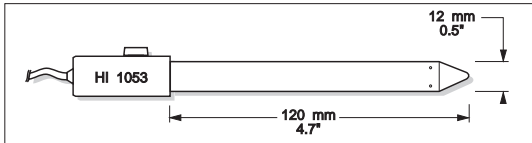

HI 1083B

Glass body, micro, Viscolene, non-refillable, combination pH electrode. Use: biotechnology, micro titration.

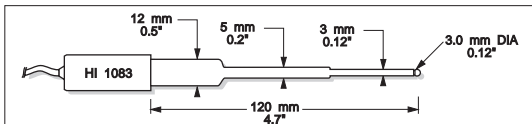

HI 1131B

Glass body, single junction, refillable, combination pH electrode. Use: general purpose.

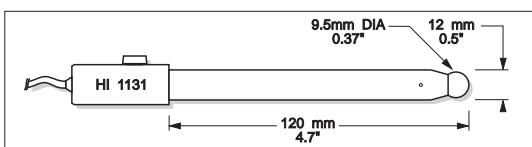

HI 1330B

Glass body, semimicro, single junction, refillable, combination pH electrode. Use: laboratory, vials.

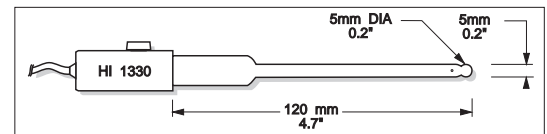

HI 1331B

Glass body, semimicro, single junction, refillable, combination pH electrode. Use: flasks.

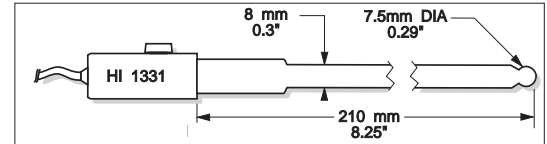

HI 1230B

Plastic body, double junction, gel-filled, combination pH electrode. Use: general, field.

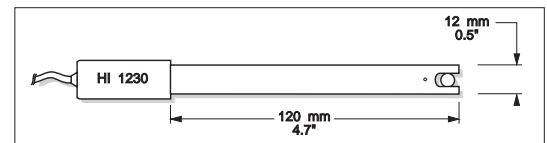

HI 2031B

Glass body, semimicro, conic, refillable, combination pH electrode. Use: semisolid products.

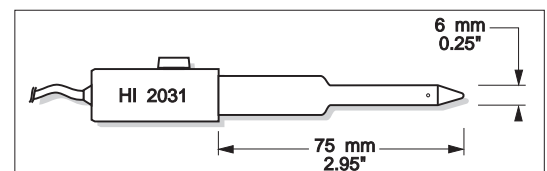

HI 1332B

Plastic body, double junction, refillable, combination pH electrode. Use: general purpose.

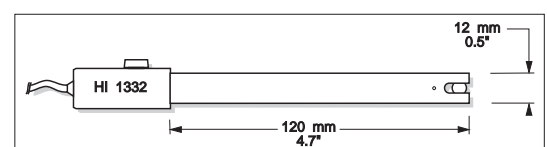

FC 100B

PVDF body, double junction, refillable, combination pH electrode. Use: general purpose for food industry.

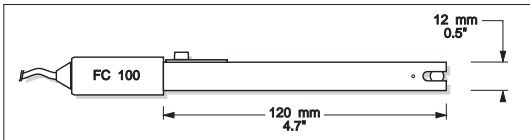

FC 200B

PVDF body, open junction, conic, Viscolene, non-refillable, combination pH electrode. Use: meat & cheese.

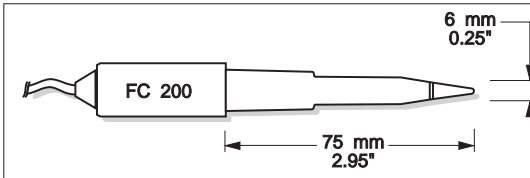

FC 210B

Glass body, double junction, conic, Viscolene, non-refillable, combination pH electrode. Use: milk, yogurt.

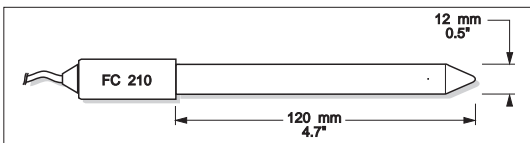

FC 220B

Glass body, triple-ceramic, single junction, refillable, combination pH electrode. Use: food processing.

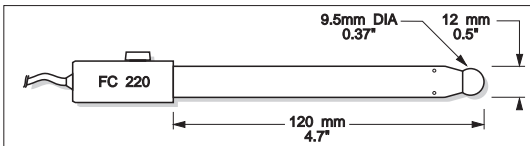

FC 911B

PVDF body, double junction, refillable with built-in amplifier, combination pH electrode. Use: very high humidity.

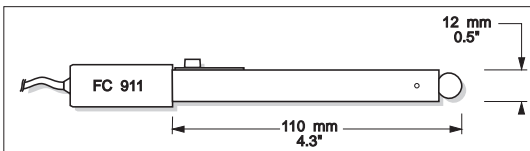

HI 1413B

Glass body, single junction, flat tip, Viscolene, non-refillable, combination pH electrode. Use: surface measurement.

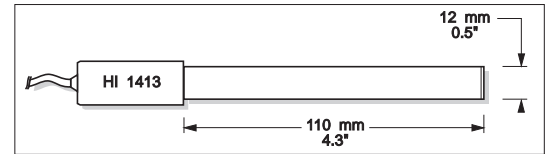

ORP ELECTRODES

HI 3131B

Glass body, refillable, combination platinum ORP electrode. Use: titration.

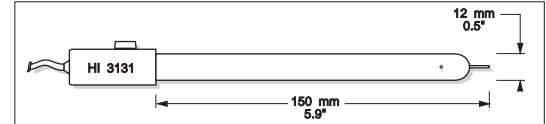

HI 3230B

Plastic body, gel-filled, combination platinum ORP electrode. Use: general purpose.

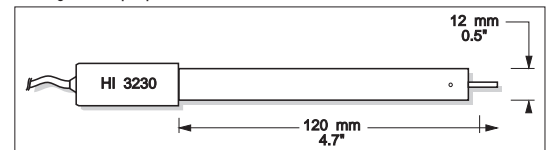

HI 4430B

Plastic body, gel-filled, combination gold ORP electrode. Use: general purpose.

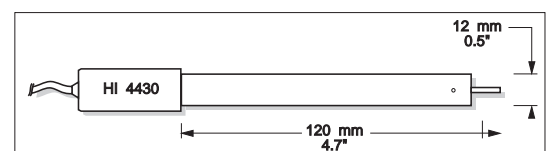

Extension cables for screw-type electrodes (screw to BNC adapter)

- HI 7855/1 Extension cable 1 m (3.3') long
- HI 7855/3 Extension cable 3 m (9.9') long
- HI 7855/5 Extension cable 5 m (16.5') long
- HI 7855/10 Extension cable 10 m (33') long

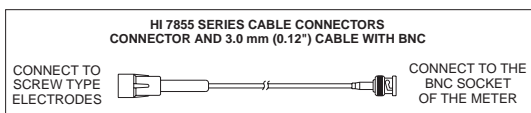

- HI 7855/15 Extension cable 15 m (49.5') long

OTHER ACCESSORIES

- HI 710005 Voltage adapter from 115 Vac to 12 Vdc
- HI 710006 Voltage adapter from 230 Vac to 12 Vdc
- ChecktempC Pocket-size thermometer (range -50.0 to 150.0°C)
- HI 76405 Electrode holder

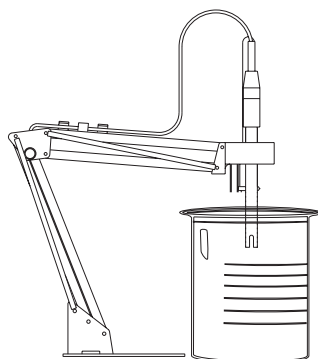

- HI 8427 pH and ORP electrode simulator with 1 m (3.3') coaxial cable ending in female BNC connectors
- HI 931001 pH and ORP electrode simulator with LCD and 1 m (3.3') coaxial cable ending in female BNC connectors

ELECTRODE APPLICATION REFERENCE GUIDE

Application	Electrodes
1. Aquarium	HI 1332B, HI 1911B
2. Bath-water	HI 1910B, HI 1130B
3. Beer	HI 1131B
4. Bread	HI 2031B, FC 200B
5. Cheese	FC 200B
6. Dairy products	FC 911B, FC 100B
7. Dirty water	HI 1910B, HI 1912B
8. Emulsions	HI 1053B
9. Environment	HI 1230B
10. Flasks	HI 1331B
11. Food industry general use	FC 911B, FC 100B
12. Fruit	FC 200B, FC 220B
13. Fruit juices, organic	FC 210B
14. Galvanizing waste solution	HI 1130B, HI 1912B
15. Heavy-duty applications	HI 1135B
16. High purity water	HI 1053B
17. Horticulture	HI 1053B, FC 200B
18. In-line applications	HI 1134B, HI 1135B, HI 2114B, HI 2910B
19. Laboratory general use	HI 1131B, HI 1230B, HI 1332B, HI 1330B
20. Leather	HI 1413B
21. Lemon juice	FC 100B
22. Meat	FC 200B, HI 2031B
23. Micro plate sampling of less than 100 mL	HI1083B
24. Milk and Yogurt	FC 210B
25. Paints	HI 1053B
26. Paper	HI 1413B
27. Photographic chemicals	HI 1230B
28. Quality control	HI 1332B
29. Sausages	FC 200B, HI 2031B
30. Semisolid products	HI 2031B
31. Skin	HI 1413B
32. Soil samples	HI 1230B
33. Solvents	HI 1043B
34. Strong acid	HI 1043B
35. Submersion application	HI 1130B
36. Surface measurements	HI 1413B
37. Swimming pool	HI 1130B, HI 2114B, HI 2910B
38. Titrations with constant temperature range	HI 1131B
39. Titrations with wide temperature range	HI 1131B
40. Very high humidity	FC 911B, HI 1912B, HI 1911B
41. Vials and test tube	HI 1330B
42. Wine processing	FC 220B

WARRANTY

All Hanna Instruments meters are guaranteed for two years against defects in workmanship and materials when used for their intended purpose and maintained according to instructions. The electrodes and the probes are guaranteed for a period of six months. This warranty is limited to repair or replacement free of charge.

Damage due to accident, misuse, tampering or lack of prescribed maintenance are not covered.

If service is required, contact the dealer from whom you purchased the instrument. If under warranty, report the model number, date of purchase, serial number and the nature of the failure. If the repair is not covered by the warranty, you will be notified of the charges incurred. If the instrument is to be returned to Hanna Instruments, first obtain a Returned Goods Authorization number from the Customer Service department and then send it with shipping costs prepaid. When shipping any instrument, make sure it is properly packaged for complete protection.

All rights are reserved. Reproduction in whole or in part is prohibited without the written consent of the copyright owner.

Hanna Instruments reserves the right to modify the design, construction and appearance of its products without advance notice.

Recommendations for Users

Before using this product, make sure that it is entirely suitable for the environment in which it is used.

Operation of this instrument in residential area could cause unacceptable interferences to radio and TV equipment, requiring the operator to take all necessary steps to correct interferences.

The glass bulb at the end of the electrode is sensitive to electrostatic discharges. Avoid touching this glass bulb at all times. During calibration of instruments, ESD wrist straps should be worn to avoid possible damage to the electrode by electrostatic discharge.

To maintain the EMC performance of this equipment, the recommended cables noted in the user's manual must be used. Any variation introduced by the user to the supplied equipment may degrade the instrument's EMC performance.

To avoid electrical shock, do not use this instrument when voltages at the measurement surface exceed 24 Vac or 60 Vdc. To avoid damage or burns, do not perform any measurement in microwave ovens.

CE DECLARATION OF CONFORMITY



DECLARATION OF CONFORMITY

We

Hanna Instruments Italia Srl
via E.Fermi, 10
35030 Sarmeola di Rubano - PD
ITALY

herewith certify that the bench-top pH meter

pH 209

has been tested and found to be in compliance with EMC Directive 89/336/EEC and Low Voltage Directive 73/23/EEC according to the following applicable normative:

EN 50082-1: Electromagnetic Compatibility - Generic Immunity Standard
IEC 801-2: Electrostatic Discharge
IEC 801-3: RF Radiated
IEC 801-4: Fast Transient

EN 50081-1: Electromagnetic Compatibility - Generic Emission Standard
EN 55022: Radiated, Class B

EN61010-1: Safety requirements for electrical equipment for measurement, control and laboratory use

Date of Issue: 26-3-1999

P. Cesa - Technical Director
On behalf of
Hanna Instruments S.r.l.



DECLARATION OF CONFORMITY

We

Hanna Instruments Italia Srl
via E.Fermi, 10
35030 Sarmeola di Rubano - PD
ITALY

herewith certify that the bench-top pH meter

pH 209R

has been tested and found to be in compliance with EMC Directive 89/336/EEC and Low Voltage Directive 73/23/EEC according to the following applicable normative:

EN 50082-1: Electromagnetic Compatibility - Generic Immunity Standard
IEC 801-2: Electrostatic Discharge
IEC 801-3: RF Radiated
IEC 801-4: Fast Transient

EN 50081-1: Electromagnetic Compatibility - Generic Emission Standard
EN 55022: Radiated, Class B

EN61010-1: Safety requirements for electrical equipment for measurement, control and laboratory use

Date of Issue: 27-3-2001

A. Marsilio - Technical Director
On behalf of
Hanna Instruments S.r.l.